

**CATALOG 2026**

*Secure Mounts for Tablets & Devices*

# Everyday Connections, Enhanced



[compulocks.com](http://compulocks.com)

**COMPULOCKS**  
DISPLAY. SECURE. ENGAGE.

# About Us

Compulocks is the leading design manufacturer of IT hardware security and tablet display solutions for businesses and across industries.

With an in-house R&D team and an understanding of every work environment's needs, we provide our clients with high end customer specific products that elevate their work, operations, and communications.

|   |  |  |   |
|---|--|--|---|
| <b>Quality Assurance</b><br>Durable materials for long-term usage | <b>Security Experts</b><br>Creating security solutions for over 10 years | <b>International Service</b><br>Operations in North America and Europe serving the world | <b>Fortune 500</b><br>Chosen by companies from start-ups to Fortune 500 |
|---|--|--|---|

# DESIGNED FOR PEOPLE, ENGINEERED FOR PERFORMANCE

Practical, secure products that streamline workflows and protect devices in any environment.





## We Went ECO

Compulocks is committed to sustainability and recognize our responsibility to minimize our environmental impact. Our goal is to create innovative and secure solutions for our customers while ensuring our operations are conducted in a sustainable and ethical manner. This policy outlines our commitment to sustainability across all aspects of our business.

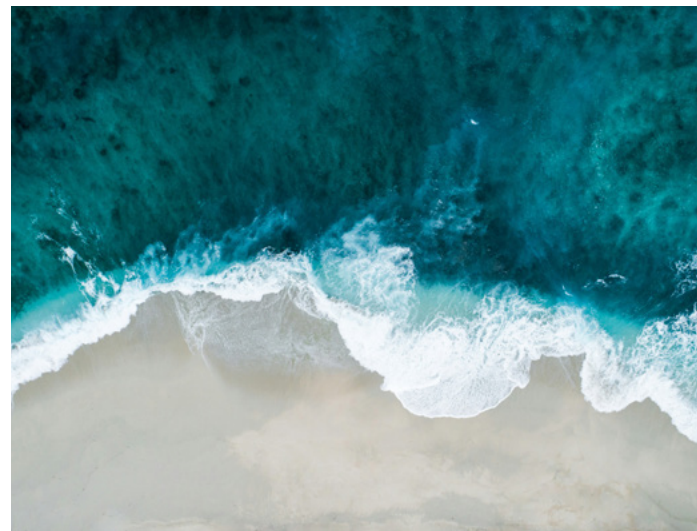

## Our Renew & Recycle Program

Our Renew & Recycle Program empowers customers to return their end-of-life products, ensuring responsible recycling and repurposing.



**80%**  
of the materials from returned products are **either recycled or repurposed**



## Renew & Recycle

### Stage 1

#### Contact Us

Email [eco@compulocks.com](mailto:eco@compulocks.com)

to get your free shipping return labels.

### Stage 2

#### Send & Disassemble

Ship us your products, and we'll disassemble and sort materials.

### Stage 3

#### Recycle Responsibly

Partnering with recycling companies, we ensure all parts are sustainably recycled.

### Stage 4

#### Greener World

Together, we create a more sustainable future.

# How Do You Want to Mount Your Tablet?

All Compulocks tablet holders pair seamlessly with our floor, wall, or counter displays to suit any device or setup. Create your ideal combination from our versatile options.

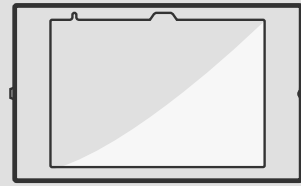

Apex



Mast Stand

Brandable Floor Stand

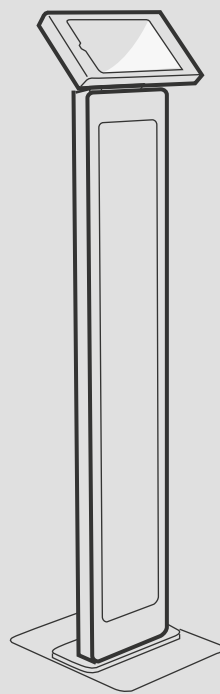

Sleek metal frame  
Quick keyed access  
Easy and quick installation

[LEARN MORE](#)

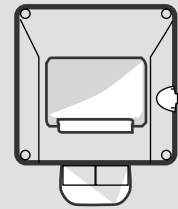

PowerMove



Wall Mount

Rise Stand

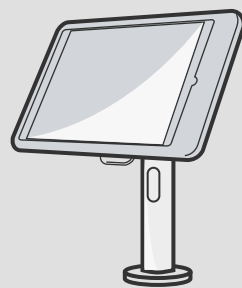
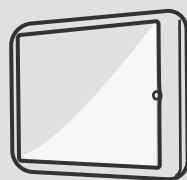

Charging display  
Click on/off  
Allows mobility

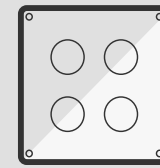

Magnetix



AV Capsule Stand

Core Stand

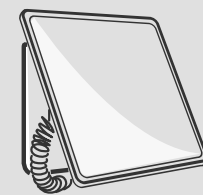

Universal  
Allows mobility  
Click on/off

[LEARN MORE](#)

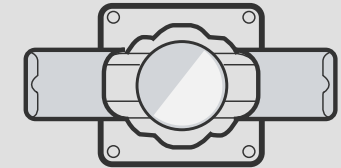

Cling



Mast Stand

Swift Floor Stand

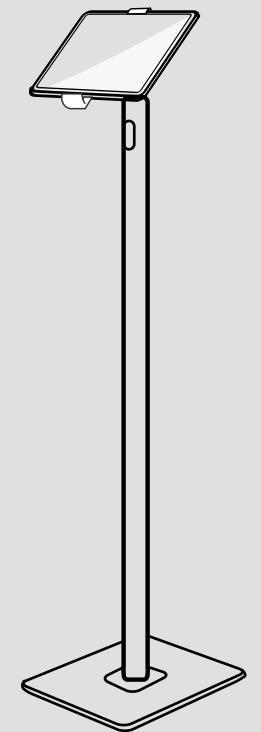

Universal  
Portrait/Landscape orientation  
Intuitive design

[LEARN MORE](#)

NEW!



## BrandMe Floor Stand for Samsung E-Paper

The BrandMe Stand is a freestanding digital display solution designed for large screens and interactive signage. Together, with the VESA 100x100 to 200x200 mounting plate adapter, it is a perfect fit for the 32-inch Samsung Color E-Paper (EM32DX model).



## Brandable Floor Stand for Large Screens

- Max screen size and weight: 32", 9Kg/19.8lbs
- Easy installation
- 200x200 mm VESA compatible mount
- Adjustable viewing angle
- Wire management through stand
- 2mm thick polypropylene graphic panel included
- The setup allows for either free-standing base or base bolted to the floor.

[LEARN MORE](#)



## Lighting Kit for the Brandable floor Stand

- Easy installation
- Full area lighting
- Efficient space management

[LEARN MORE](#)

NEW!



## Swing Arm

- 75x75mm VESA Mount
- 100x100mm VESA Mount
- AI high-grade aluminum
- Tilt & Pan
- Swivel

- VESA 75x75 & 100x100 compatible
- Extends from 4.5" to 10.2" (11.5-26 cm) from the wall
- Secure & easy install
- Supports up to 4.8 lb (1.95 kg)
- Sleek, eco-conscious design
- Max Screen Size: 15"



LEARN MORE

## Bow Wall Mount

- 75x75mm VESA Mount
- 100x100mm VESA Mount
- AI high-grade aluminum
- Tilt / Pan

- Tilt or pan screen based on installation
- Secures to any flat surface
- Four cable exit options
- Easy hinge adjustment
- Portrait or landscape mountable
- Max screen size: 27"
- Supports up to 10lb / 4.5kg
- Black or white

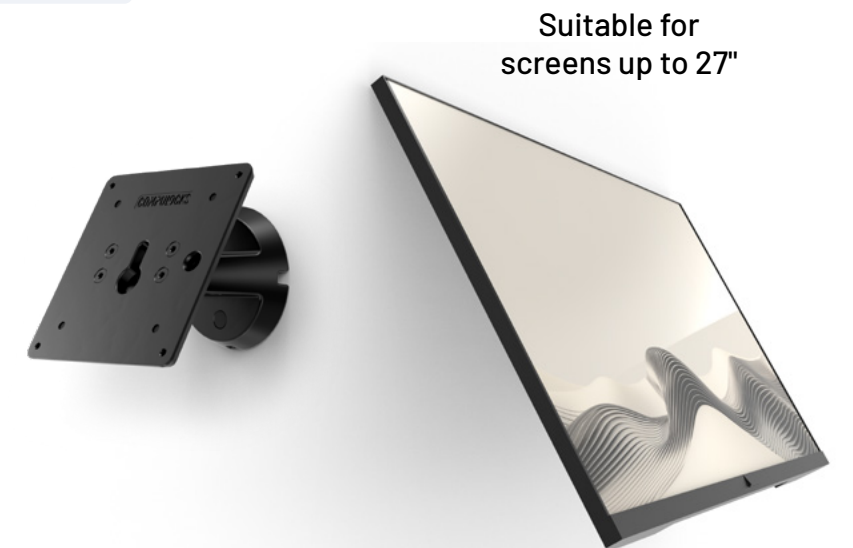

LEARN MORE

PLAY THE VIDEO



Made from 98% recyclable aluminum with 30% recycled content, offering durable, eco-friendly protection.

NEW!



## Rise Stand

75x75mm  
VESA Mount

100x100mm  
VESA Mount

**AI**  
Aluminum high-grade  
aluminum

Tilt

Swivel

The Rise Stand is a sleek, secure countertop display for tablets and monitors, compatible with 75x75mm and 100x100mm VESA mounts and all Compulocks' enclosures and universal secured tablet mounts. Its wide tilt range and clean cable routing make it ideal for retail, hospitality, and POS use. Built with durable materials, it's available in two pole heights to fit any counter layout.

LEARN MORE

## VESA Stand with Cable Management



Swivel and tilt



75x75mm and 100x100 mm  
VESA-compatible mount



Two heights  
4"/10 cm or 8"/ 20 cm



Cable management  
through pole

- VESA 100mm x 100mm and 75mm x 75mm compatible
- Allows continuous charging while the device is mounted
- Two stand height options
- Swivel and tilt head
- Supports up to 10lb / 4.5kg
- Built-in cable management
- Works with our security cable lock
- Max Screen Size: 20"



Optional bases available  
Adhesive Stability Base for the Rise  
Stand (**STB3B**)

NEW!



## Swift Floor Stand

75x75mm  
VESA Mount

100x100mm  
VESA Mount

AI high-grade  
aluminum

Tilt

lightweight

The Swift Floor Stand is a lightweight, durable aluminum display built for easy setup and mobility. Ideal for trade shows, pop-ups, and retail spaces, it assembles with a single screw and includes floor-mount and cable lock options for secure installation.

LEARN MORE

PLAY THE VIDEO

### Quick Setup, Best Value Pricing



Tilting mount



75x75mm and 100x100 mm  
VESA-compatible mount



Freestanding or floor-  
mountable with four screws

- 75x75mm and 100x100 mm VESA-compatible mount
- Supports monitors up to 15.6" and 11lb (5kg)
- Stands 3.1 ft (95.5 cm) tall
- Large cable openings for easy cable management
- Can be used freestanding or secured with four screws

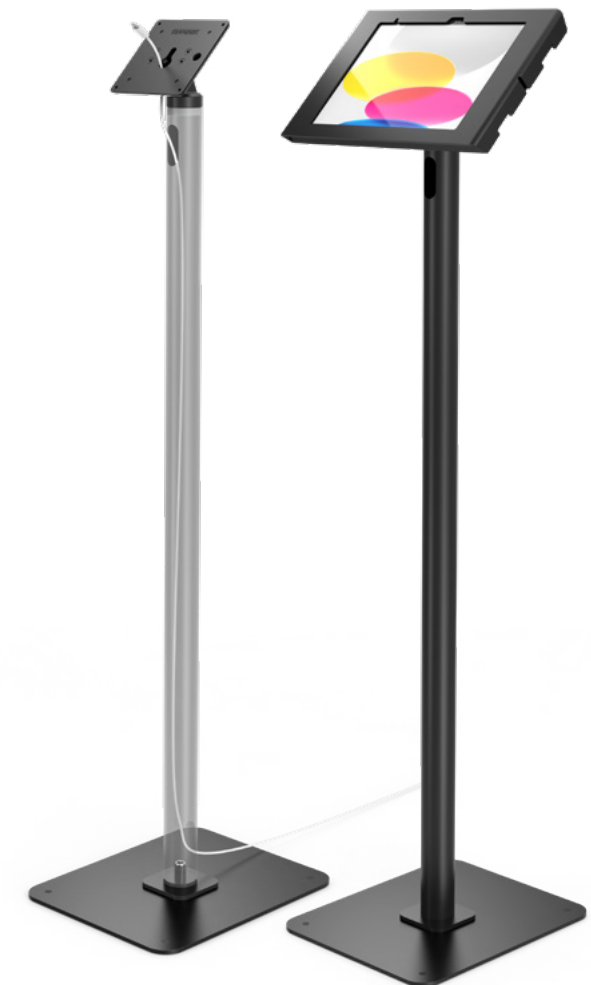

Large cable openings  
for streamlined  
integration

NEW!



Secure Locking Mechanism



Powerful USB-C Charging System



Spacious & Device-Friendly Slots



Easy Monitoring

## Charging & Locking Cabinet

*Lock & Recharge all devices at once, easily*

The Charging & Locking Cabinet for 16 Notebooks & Tablets securely stores, charges, and organizes laptops, Chromebooks, tablets, and iPads up to 15.6". Built with durable, high-performance materials and a compact design, it's ideal for educational, business, and public settings.

LEARN MORE

PLAY THE VIDEO 

## Charging & Locking Cabinet for 16 Notebooks & Tablets USB-C PD 3.0 (Up to 1000W)

- Powerful USB-C charging system
- Spacious & device-friendly slots
- Easy monitoring
- Rugged, durable construction
- Wall-mountable for space efficiency
- Active ventilation system
- Security mechanism with combination lock and backup key
- 1000W total / max 100W per port
- 16 USB-C cables with 90° connector are included.

## WALL DISPLAYS



## Wall Displays



Portrait or Landscape installation

### Apex

100x100mm VESA Mount | 75x75mm VESA Mount | Compatible   

- Sleek metal frame
- Quick Lock / Unlock Keyed Mechanism
- Option for direct wall mounting
- Exposed front and back cameras and sensors
- Conceals charging cable
- Compatible with all Compulocks' VESA stands and mounts



Made from 98% recyclable aluminum with 30% recycled content, offering durable, eco-friendly protection.

[LEARN MORE](#)



Portrait or Landscape installation

### Swell

Compatible   100x100mm VESA Mount | 75x75mm VESA Mount



Made from 98% recyclable aluminum with 30% recycled content, offering durable, eco-friendly protection.

- Metal construction for extra durability
- Closed and minimal design for maximum protection of the tablet
- Tamperproof screws
- Exposed front and back cameras including sensors
- Conceals charging cable
- Compatible with all Compulocks' VESA stands and mounts

[LEARN MORE](#)

### Space

Compatible    100x100mm VESA Mount



Portrait or Landscape installation

- High-grade aluminum enclosure with rounded edges
- Quick Lock / Unlock Keyed Mechanism
- Conceals charging cable
- Designed to expose cameras and sensors
- Compatible with all Compulocks' VESA stands and mounts



Made from 98% recyclable aluminum with 30% recycled content, offering durable, eco-friendly protection.

[LEARN MORE](#)

## WALL DISPLAYS



## Wall Displays



### Magnetix Wall Mount

100x100mm VESA Mount **Compatibility: Universal**

- Universal mount system for all iPads / tablets
- For displays and handheld use, cable lock secured
- Easily switch between landscape and portrait orientations
- Max Load: 5lb / 2.27kg
- Max Screen Size: 13" / 33cm
- Compatible with all Compulocks' VESA stands and mounts

[LEARN MORE](#)

[PLAY THE VIDEO](#)

### IT Mount Bow Tilting Wall Mount **NEW!**

100x100mm VESA Mount **Compatibility: Universal**

- Tilt or pan screen
- Four cable exit options
- Easy hinge adjustment
- Fits to any flat wall
- Industrial strength stick pads
- Max Load: 5lb / 2.27kg
- Max Screen Size: 13" / 33cm
- Tamper-proof screws
- Can be repurposed and used again on other displays, using a new set of sticker pads

[LEARN MORE](#)



### Cling Wall Mount

100x100mm VESA Mount **Compatibility: Universal**

- Universal, compatible with iPads / tablets 7" - 13", Max thickness: 9.3mm
- Max Load: 5lb / 2.27kg
- Rotates between portrait and landscape orientations
- Tamperproof design
- Secure cable management

[LEARN MORE](#)



### Apex Enclosure Swing Wall Mount **NEW!**

**Compatible**   

- Sleek metal frame
- Quick Lock / Unlock Keyed Mechanism
- Extends from 4.5" to 10.2" (11.5-26 cm) from the wall
- Tilt, pan, and swing for multiple display angles
- Secure & easy install
- Supports up to 4.8 lb (1.95 kg)

[LEARN MORE](#)





## Counter Stands

Made with high-quality materials, our tablet kiosk stands have a harmonious design, advanced security features, and are easy to install. They are adaptable to all types of environments. They ensure a perfect fit no matter the size, make, or model.



Made from 98% recyclable aluminum with 30% recycled content, offering durable, eco-friendly protection.

### Apex Enclosure Core Stand

Compatible   

- Powder-coated steel stand
- Enclosure can be set in landscape or portrait orientation
- Wall or countertop mountable
- Add-on adhesive and Swivel bases

[LEARN MORE](#)



### Swell Enclosure Mast Stand

Compatible  

- Metal construction for extra durability
- Full reverse tilt
- Cable management
- Tilt tension screws
- Optional Stability base add-on

[LEARN MORE](#)



### Glidetab Lock Stand NEW!

Compatibility: Universal

- Universal tablet and iPad stand
- Portrait or landscape orientation
- Keyed lock for easy removal
- 60° table top viewing angle
- Countertop or wall-mounted setup

[LEARN MORE](#)

[PLAY THE VIDEO !\[\]\(a6d218fda85459cf4be8bc85de67752f\_img.jpg\)](#)



## Tablet Printer Kiosk

[PLAY THE VIDEO](#)

100x100mm VESA Mount | 75x75mm VESA Mount COMPATIBILITY **EPSON** EXCEED YOUR VISION **star**

Compatible

- Securely mount a variety of tablets and iPads
- Sturdy, high-quality iPad/tablet holder
- Printer dimensions - H- 160 mm / 6.3 in, W- 130 mm / 5.12 in, D- 150 mm / 5.91 in
- Base can be securely bolted onto the countertop
- Embedded and removable stability base for a freestanding setup
- Max Load: 5.51lb / 2.5 kg
- Max Screen Size: 15"

[LEARN MORE](#)



Made from 98% recyclable aluminum with 30% recycled content, offering durable, eco-friendly protection.



## Secured KickStand

Compatible

- Metal kickstand for durability
- 6ft Keyed Cable lock included
- Dual angle - 7.5° and 30° stances
- Rubber feet for stability and traction
- Easy installation with 3M VHB pads

[LEARN MORE](#)

[PLAY THE VIDEO](#)



## Apex Rise Stand

Compatible

- 2 Height options available
- Through arm cable management
- Swiveling and tilting mount head
- Optional adhesive and freestanding bases

[LEARN MORE](#)



## Apex AV Capsule Stand

Compatible

- Concealed storage space for cables and battery
- 30° table top, 60° wall mounted viewing angle
- Built-in cable lock slot

[LEARN MORE](#)

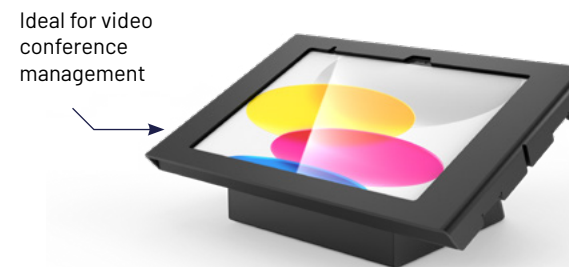

Made from 98% recyclable aluminum with 30% recycled content, offering durable, eco-friendly protection.



## Floor Stands

Made with high-quality materials, our Floor stands have a harmonious design, advanced security features, and are easy to install. They are adaptable to all types of environments. They ensure a perfect fit no matter the size, make, or model.



### Swift Floor Stand NEW!

100x100mm VESA Mount | 75x75mm VESA Mount

- Supports monitors up to 15.6" and 11lb (5kg)
- Stands 3.1 ft (95.5 cm) tall
- Large cable openings for easy cable management
- Can be used freestanding or secured with four screws

[LEARN MORE](#)

[PLAY THE VIDEO](#)

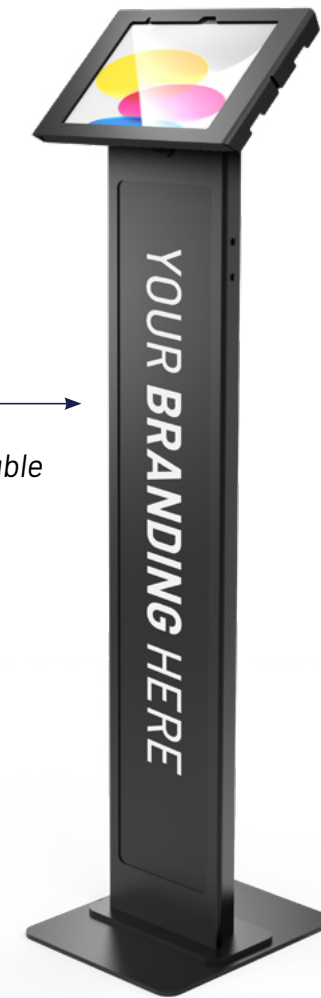

### Brandable Floor Stand

100x100mm VESA Mount | 75x75mm VESA Mount

- Panel for branding, call to action, or custom design
- Internal lighting option for backlit branding
- Tilting mounting plate
- Cable management for charging while mounted
- Concealed storage space for adaptor, batteries, etc.

[LEARN MORE](#)



**ROLLING STANDS**

## Rolling Stands

Make any tablet a mobile, hands-free workstation for bedside care.

Our rolling stands combine VESA compatibility, adjustable height and viewing angles, integrated cable management, and a lockable battery box to protect power and data. A work shelf, storage basket, and locking wheels keep devices and supplies organized and stable in busy clinical environments.

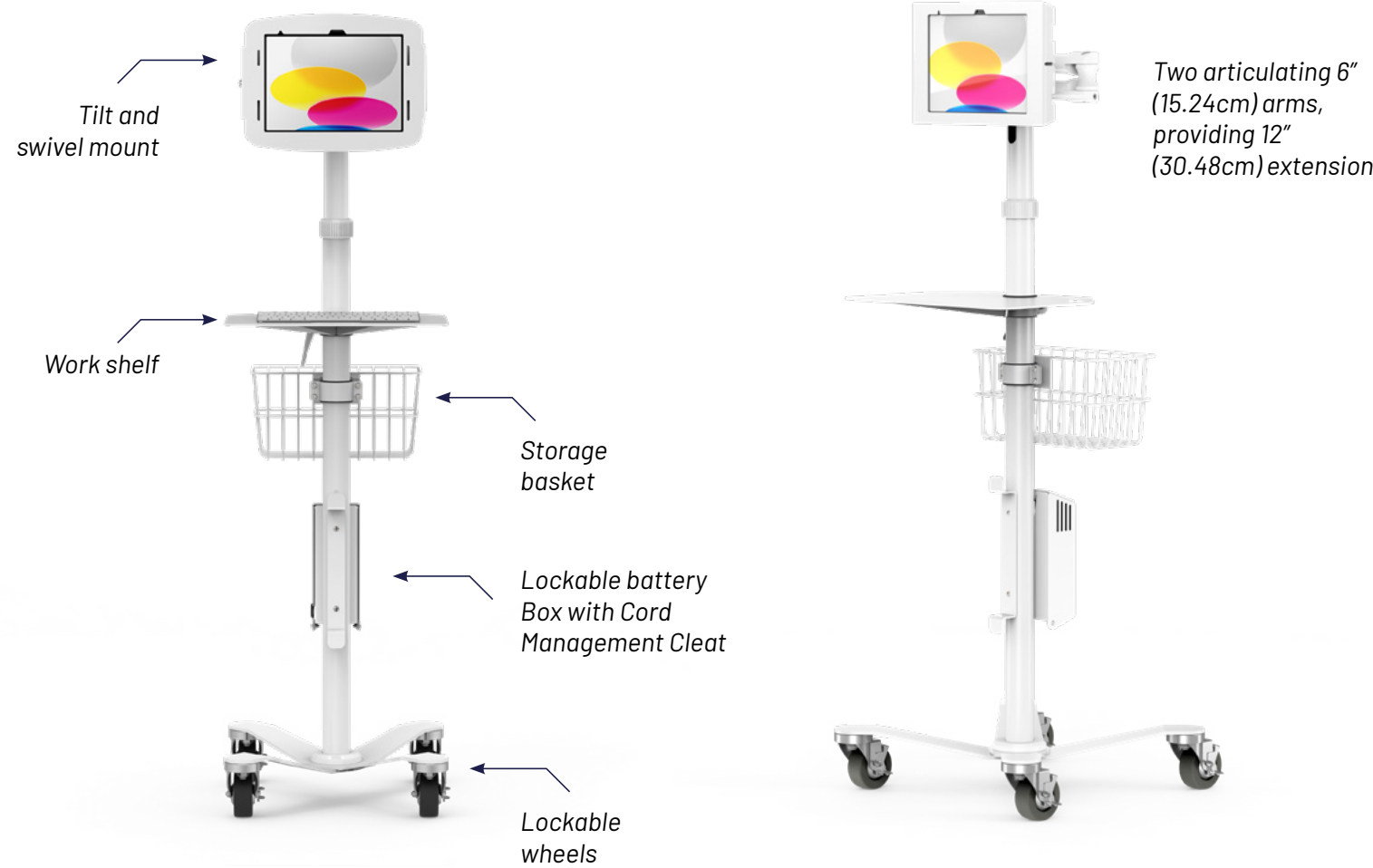

### Tablet Rolling Cart

100x100mm VESA Mount | 75x75mm VESA Mount

- Dynamic, rolling, hands-free workstation
- Through pole cable management
- Adjustable height and viewing angles
- Rolls easy and fits in tight spaces
- Perfect for healthcare and medical settings

[LEARN MORE](#)

[PLAY THE VIDEO](#)

### Premium Tablet Rolling Cart

100x100mm VESA Mount | 75x75mm VESA Mount

- Locking wheels for smooth, secure mobility
- Heavy-duty base for added stability
- Dual-jointed arm extends up to 12"
- Adjustable tilt with secure angle lock
- 1-screw assembly for fast setup
- Clean cable routing with pass-through

[LEARN MORE](#)

[PLAY THE VIDEO](#)



## Other Mounts

### Glass Mount

100x100mm  
VESA Mount

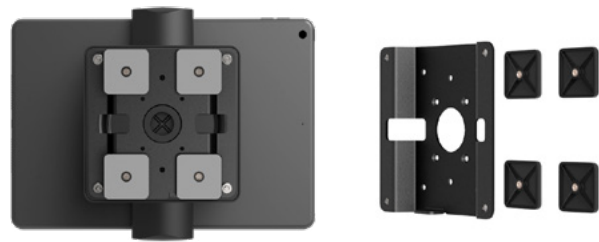

- Securely mount any iPad or tablet on smooth surfaces including marble and glass; no drilling required
- Easy to install and can be removed using a dedicated tool (supplied separately)
- Powerful VHB adhesive pads to fix to glass and other smooth surfaces
- Max Load 4.4lb / 2kg
- Max Screen Size: 13"

[LEARN MORE](#)



### Rail Mount

100x100mm VESA Mount | 75x75mm VESA Mount

- Fix to rails 12.7mm (0.5") Ø to 38.0mm (1.50") Ø
- 340° screen swivel
- 125° screen flip
- Max Load: 10lb / 4.5kg
- Max Screen Size: 15"

[LEARN MORE](#)





## Apple Mounts



### Apple TV Security Mount

Compatible with all Apple TV models

- Easy fix to any flat surface
- Lightweight and low profile
- Ventilated aluminium construction
- Security slot for lockhead or cable lock

LEARN MORE

Best Seller



Made from 98% recyclable aluminum, including 30% recycled content for durable, eco-friendly protection.



### Mac mini Security Mount

Compatible with all Mac mini models

- Lightweight and low profile
- High-grade aluminum construction
- 100x100mm and 75x75mm VESA Mounting Pattern
- Security slot for lockhead or cable lock

LEARN MORE

Best Seller



Built from 98% recyclable aluminum with 70% recycled content for strong, sustainable protection.



Made from 98% recyclable aluminum, including 70% recycled content for durable, eco-friendly protection.

## Mac Studio Locks

Mount | 100x100mm VESA Mount

- Secures directly to a flat surface or freestanding secured with cable lock
- Additional T-Bar lock slot for peripheral
- Ventilated design
- Unrestricted access to ports

LEARN MORE

## Ledge Lock

- Unique Ledge lock adapter mechanism
- Creates accessible T-Bar lock slot compatible with standard cable locks
- Non-invasive
- Low profile solution

LEARN MORE



## Stand

- Mac Studio secured with cable lock to stand or fixed point
- Increases ventilation and decreases dust accumulation
- Allows use of standard T-Bar cable locks
- Maintains small footprint
- Additional T-Bar lock slot for peripheral

LEARN MORE



PLAY THE VIDEO 



## Mobility. Connectivity. Security.



The keyed lock keeps your iPad or tablet secure in any environment, while built-in pogo pins ensure continuous charging and data transfer.

Now available for  
Galaxy Tab A9+ and  
Galaxy Tab A11+



## PowerMove

PowerMove is an all-in-one solution for USB-C iPads and tablets, providing constant charging, data transfer, and easy mobility with its Lift-to-Release mechanism.

Compatible with Compulocks counter, VESA wall, and floor stands.

## Streamline Your Operations

Ideal for any industry—from customer service and warehousing to quality control and on-the-go sales.

LEARN MORE

## PowerMove Features

100x100mm  
VESA Mount

- Pogo pins for connectivity and charging
- Allows data and power transfer through USB-C interface
- Locking mechanism for tablet security
- Direct charging port when detached from dock
- Rugged case available for iPad 10-11 Gen, Galaxy Tab A9+, and Galaxy Tab A11+
- Easy to use “lift to release” mechanism
- Integrated security slot, USB-C charging port and kickstand on tablet back side





## Plus Hub

The Plus Hub is a multi-functional media add-on that enhances tablet connectivity. Designed for Compulocks counter, wall, and floor stands, it offers a sleek, organized solution for managing connections.

Group your cables and ports for a clean, efficient, and professional workspace.

[LEARN MORE](#)

[PLAY THE VIDEO](#)



## Connectivity Reimagined



Connect your tablet to a display, printer, scanner, or keyboard for seamless presentations and productivity – the Plus Hub makes every connection simple and efficient.



## The Plus Hub Features

100x100mm  
VESA Mount

- Hub ports specification : USBPD, USB-C, HDMI, 2xUSB-A, RJ45
- Allows data and power transfer through USB-C interface
- Ventilation holes incorporated to ensure proper temperature regulation
- Option for direct wall mounting

## Compatibility

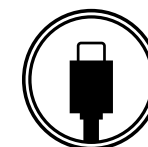

Compatible with all products with a USB-C port



## Ergonomic Arm

100x100mm VESA Mount | 75x75mm VESA Mount

- Wide range of motion: tilt, swing, and pan
- Clamp-on, mount through desk or wall mount
- Cable management keeps all wires and cords

LEARN MORE

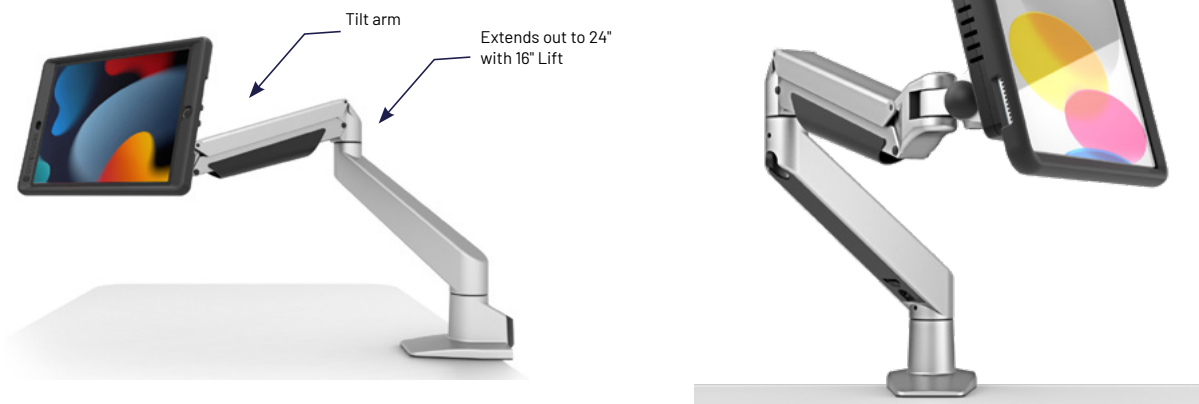

## MacBook Ledge Lock

Since MacBook Pro and Air models lack built-in security slots, Compulocks offers exclusive "Ledge" T-Slot adapters for each model.

- Models compatible with all MacBook Pro and Air
- Compatible with standard T-Bar cable locks
- Cutting-edge design for maximum security
- Small size and weight

LEARN MORE

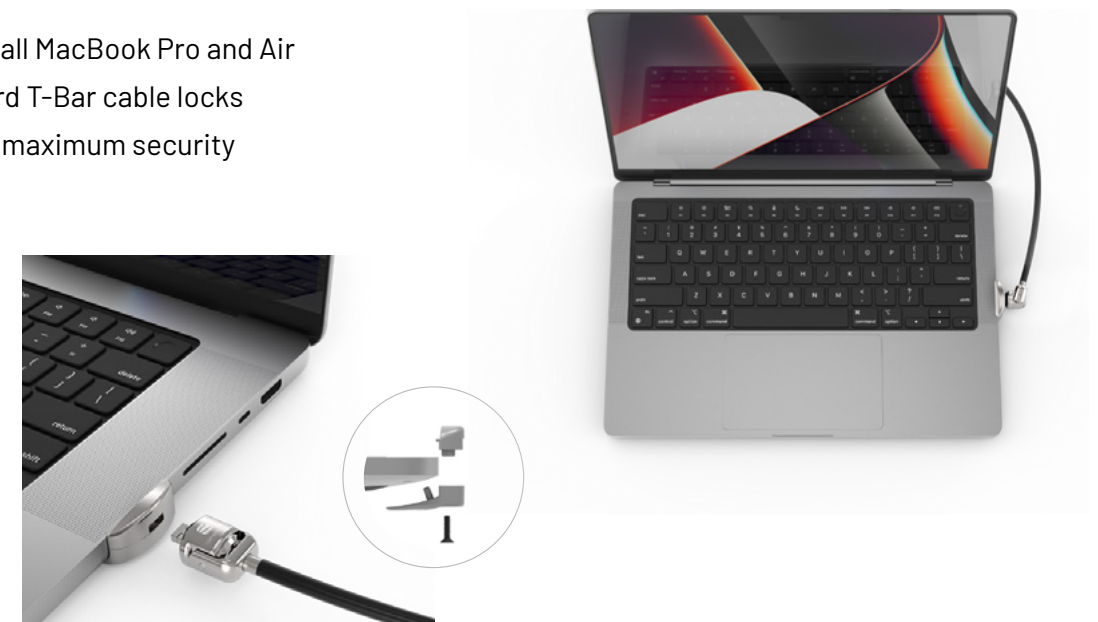



## Lock Adapters & Cable Locks



### Universal Tablet Lock

**Compatible: Universal**

- Low-profile Universal Security Plate
- 3M VHB industrial adhesive
- 6ft galvanized steel cable lock
- Loop-ended cable for easy tethering

LEARN MORE

Best Seller



### Blade Universal Lock

Compatible     

- Universal for any device
- Extremely durable
- Compatible with standard T-bar cable lock
- Retractable "Blade" security slot

LEARN MORE



### Keyed Cable Lock

6ft Universal T-Bar Keyed Cable Lock

LEARN MORE



### Combination Cable Lock

6ft Universal T-Bar Combination Cable Lock

LEARN MORE



### Dual cable lock

Dual-Headed Keyed Coiled Cable Lock

LEARN MORE

## Did You Know?

The FBI's National Crime Information Center estimates that each year up to 800,000 memory devices (laptops, tablets, etc.) are lost or stolen. Due to their value, securing MacBooks, laptops, and iPads is more urgent than ever.

\*Source: forbes.com



## Universal Hand Grip



### Hand Grip

- Universal to fit all tablets and iPads
- Adjustable strap for a comfortable fit, even with gloves
- Industrial-strength adhesive
- 360 degree screen rotation

[LEARN MORE](#)

### Grip & Dock Station

- Secured 'grab and go' iPad/tablet stand
- Quick keyed lock and release system
- Wall or countertop mount

[LEARN MORE](#)

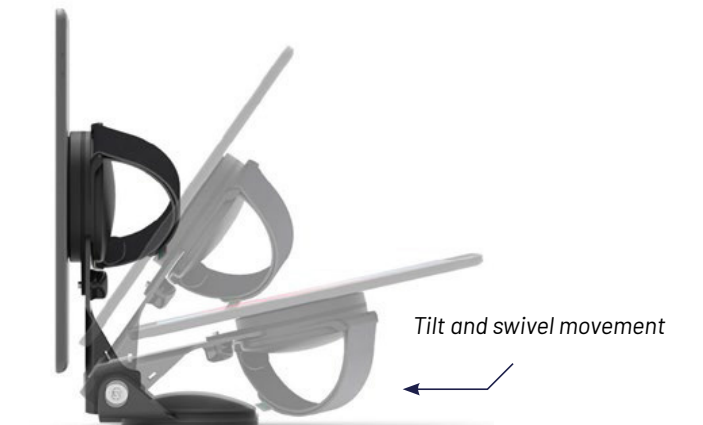

## POS Terminal Solutions

### EMV SlideDock Security Stand

- Universal device security stand
- Quick connect docking plate
- Counter-top or wall mountable
- Simple, stylish, and secure
- Comes with VHB pad and swivel base

[LEARN MORE](#)





## Store & Charge



### Charging & Locking Cabinet [LEARN MORE](#)

- Powerful USB-C charging system
- Secure locking mechanism
- Spacious & device-friendly slots
- Easy monitoring
- Rugged, durable construction
- Wall-mountable for space efficiency
- Active ventilation system

## Protective Solutions



### Edge Case [LEARN MORE](#)

- Rugged silicone protection**
- Rubberized for a firm grip and protection
  - Cutouts for buttons, ports, and cameras
  - Open back area for universal adhesive locking mechanisms



### Screen Shield [LEARN MORE](#)

- Tempered glass screen protector**
- Shatterproof and scratch-resistant
  - Maintains touchscreen sensitivity
  - Crystal clear image resolution
  - Nano-coating to repel finger marks and dust

# Your Vision, Perfected

At Compulocks, we offer customized tablet mounting solutions. Trust us to take your ideas and transform them into something extraordinary.

LEARN MORE

### Integration

Craft one-of-a-kind devices with modified enclosures for multiple gadgets.

### Branding

Personalize your solution with your logo and company colors.

### Sizing

Customize a unique size that isn't typically available in our lineup.

### Functionality

Enhance your enclosure with additional screws and custom slots.

## Get Some Design Inspiration From Other Customers



Healthcare Translations

Learn More >>



On-the-Go POS

Learn More >>



NFC for Schools

Learn More >>

Compulocks bespoke tablet printer kiosks bring **brand presence** to leading food service enterprise



Featuring a universal 100x100mm and 75x75mm VESA mount plus a retail-sized printer housing, the POS Printer Kiosk is designed for the fast-paced needs of restaurants and eateries.

This custom kiosk streamlines order processing and elevates customer interaction. Each unit can be branded with signature colors, creating a vibrant, cohesive presence in any establishment.

## Swell and Apex Enclosures

| Apple iPad                            | Screen Size in Inch | Swell Enclosure           |
|---------------------------------------|---------------------|---------------------------|
| iPad 10th-11th (A16) Gen              | 10.9" / 11"         | <a href="#">209SWLB</a>   |
|                                       |                     | Apex Enclosure            |
| iPad 10th-11th (A16) Gen              | 10.9" / 11"         | <a href="#">209APXB</a>   |
| iPad Air M2/M3                        | 11"                 | <a href="#">11APXB</a>    |
| iPad Air M2/M3                        | 13"                 | <a href="#">13APXB</a>    |
| iPad Pro M4/M5                        | 11"                 | <a href="#">11PAPX4B</a>  |
| iPad Pro M4/M5                        | 13"                 | <a href="#">13PAPX4B</a>  |
| Samsung Galaxy Tab                    | Swell Enclosure     |                           |
| Galaxy Tab A9+/A11+                   | 11"                 | <a href="#">11GSWL9B</a>  |
|                                       |                     | Apex Enclosure            |
| Galaxy Tab S10 FE+                    | 13.1"               | <a href="#">131GAPXB</a>  |
| Galaxy Tab A9+/A11+                   | 11"                 | <a href="#">11GAPX9B</a>  |
| Galaxy Tab S9/S9FE/S10FE/S10 Lite/S11 | 10.9" / 11"         | <a href="#">109GAPXB</a>  |
| Galaxy Tab S9+/S9FE+/S10+             | 12.4"               | <a href="#">124GAPXB</a>  |
| Galaxy Tab S9/S10/S11 Ultra           | 14.6"               | <a href="#">146GUAPXB</a> |
| Galaxy Tab Active 3/5                 | 8"                  | <a href="#">80GAPXB</a>   |
| Galaxy Tab A9/A11                     | 8.7"                | <a href="#">87GAPX9B</a>  |
| Microsoft Surface                     | Apex Enclosure      |                           |
| Surface Go (1st-4th Gen)              | 10.5"               | <a href="#">510APXB</a>   |
| Surface Pro (8th-11th)                | 13"                 | <a href="#">580APXB</a>   |
| Surface Pro Copilot+ PC 12"           | 12"                 | <a href="#">590APXB</a>   |

## Space Enclosures

| Apple iPad                 | Screen Size in Inch | Space Enclosure          |
|----------------------------|---------------------|--------------------------|
| iPad (7th-9th Gen)         | 10.2"               | <a href="#">102IPDSB</a> |
| iPad mini (6th-7th Gen)    | 8.3"                | <a href="#">830IPMSB</a> |
| Samsung Galaxy Tab         |                     |                          |
| Samsung Galaxy Tab A8      | 10.5"               | <a href="#">105GA8SB</a> |
| Samsung Galaxy Tab A7 Lite | 8.7"                | <a href="#">870GA7SB</a> |

## PowerMove

| Apple iPad               | Screen Size in Inches | PowerMove               |
|--------------------------|-----------------------|-------------------------|
| iPad 10th-11th (A16) Gen | 10.9" / 11"           | <a href="#">PMIP109</a> |
| Samsung Galaxy Tab       | Screen Size in Inches | PowerMove               |
| Galaxy Tab A9+           | 11"                   | <a href="#">PMGA9P</a>  |
| Galaxy Tab A11+          | 11"                   | PMGA11P                 |







## Apple Mounts

| Apple TV                  | Security Mount          |                            |                         |                         |
|---------------------------|-------------------------|----------------------------|-------------------------|-------------------------|
| Apple TV 4K (3rd Gen)     | <a href="#">ATVEN43</a> |                            |                         |                         |
| Apple TV 4K (1st-2nd Gen) | <a href="#">ATVEN35</a> |                            |                         |                         |
| Mac mini                  |                         |                            |                         |                         |
| Mac mini M4               | <a href="#">MMEN24</a>  |                            |                         |                         |
| Mac mini M1/M2            | <a href="#">MMEN76</a>  |                            |                         |                         |
| Mac Studio                | Lock adapter            | Lock adapter with key lock | Bracket Mount           | Desktop Stand           |
| Mac Studio                | <a href="#">MSLDG01</a> | <a href="#">MSLDG01KL</a>  | <a href="#">MSBKT01</a> | <a href="#">MSSTD01</a> |











## Apple Locks

| Apple MacBook                            | Ledge Lock Adapter          | Lock Adapter With Key Lock    | Lock Adapter with Combination Lock  |
|--|-----------------------------|-------------------------------|-------------------------------------|
| MacBook Pro/Max 16-inch (M1/M2/M3/M4)    | <a href="#">MBPR16LDG02</a> | <a href="#">MBPR16LDG02KL</a> | <a href="#">MBPR16LDG02CL</a>       |
| MacBook Pro/Max 14-inch (M1/M2/M3/M4/M5) | <a href="#">MBPR14LDG01</a> | <a href="#">MBPR14LDG01KL</a> | <a href="#">MBPR14LDG01CL</a>       |
| MacBook Air 15-inch (M2/M3/M4)           | <a href="#">MBALDG05</a>    | <a href="#">MBALDG05KL</a>    | <a href="#">MBALDG05CL</a>          |
| MacBook Air 13-inch (M2/M3/M4)           | <a href="#">MBALDG04</a>    | <a href="#">MBALDG04KL</a>    | <a href="#">MBALDG04CL</a>          |
|  |                             | Blade Bracket                 | Blade Bracket with keyed lock       |
|  |                             |                               | Blade Bracket with Combination lock |
| All MacBooks                             | <a href="#">BLD01</a>       | <a href="#">BLD01KL</a>       | <a href="#">BLD01CL</a>             |

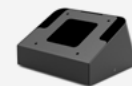
## Universal Solutions

|          |   |   |  |   |   |   |   |   |   |
|----------|---|---|--|---|---|---|---|---|---|
|          |  |  |  |  |  |  |  |  |  |
| Solution | Glidetag  | Grip & Dock   | Universal Tablet Lock  | Secured EMV Stand   | Universal Tablet Holder   | Solutions with Cling  | Solutions with IT-mount   | Solutions with Magnetix   | Tablet Rugged Case Stand  |
| Part #   | <a href="#">GLDTABB</a>   | <a href="#">189BGRPLCK</a>  | <a href="#">CL15UTL</a>  | <a href="#">199BSLDDCKB</a>   | <a href="#">CL12UTHBB</a>   | <a href="#">UCLGVWMB</a>  | <a href="#">SMP01B</a>  | <a href="#">VHBMM01</a>   | <a href="#">820BRCH</a>   |

## Stands and Wall Mounts

|          |   |   |   |   |   |   |   |   |   |   |
|----------|---|---|---|---|---|---|---|---|---|---|
|          |  |  |  |  |  |  |  |  |  |  |
| Solution | Mast Stand  | Fixed 45° - Core Stand  | Tilting 8" Counter Stand - Rise   | Tilting 4" Counter Stand - Rise   | AV Conference Room Capsule  | Tablet Printer Kiosk  | Articulating Arm Mount - Reach  | Flexible Counter Stand - Flex Arm   | Tilting Wall Mount - Bow  | Swing Wall Mount - Swing  |
| Part #   | <a href="#">333B</a>  | <a href="#">111B</a>  | <a href="#">TCDP01</a>  | <a href="#">TCDP04</a>  | <a href="#">341B</a>  | <a href="#">PK01</a>  | <a href="#">660REACH</a>  | <a href="#">159B</a>  | <a href="#">505B</a>  | <a href="#">827B</a>  |

## Stands

|          |   |   |  |   |   |   |   |   |
|----------|---|---|--|---|---|---|---|---|
|          |  |  |  |  |  |  |  |  |
| Solution | Brandable Floor Stand - BrandMe   | Swift Floor Stand   | Brandable VESA Floor Stand for Screens Up to 32 Inches                               | Brandable VESA Floor Stand for the Samsung E-Paper                                    | VESA Brandable Floor Stand with Lighting Kit UK Power Cord                            | VESA Brandable Floor Stand with Lighting Kit EU Power Cord                            | Premium Rolling Cart  | Rolling Cart - Rise Freedom   |
| Part #   | <a href="#">140B</a>  | <a href="#">150B</a>  | <a href="#">140BLBPB</a>   | <a href="#">140B200LBPB</a>   | <a href="#">140BLK01-UK</a>   | <a href="#">140BLK01-EU</a>   | <a href="#">170W</a>  | <a href="#">MCRSTDW</a>   |

## Security KickStand

| Apple iPad               | Screen Size in Inches | Security KickStand        |
|--------------------------|-----------------------|---------------------------|
| iPad 10th-11th (A16) Gen | 10.9" / 11"           | <a href="#">109KS01KL</a> |
| iPad (7th-9th Gen)       | 10.2"                 | <a href="#">102KS01KL</a> |
| iPad Mini (6th-7th Gen)  | 8.3"                  | <a href="#">830KS01KL</a> |
| Samsung Galaxy Tab       | Screen Size in Inches | Security KickStand        |
| Galaxy Tab A9+           | 11"                   | <a href="#">11KS01KL</a>  |
| Galaxy Tab A9            | 8.7"                  | <a href="#">870KS01KL</a> |

## Protective Accessories

| Apple iPad                            | Screen Size in Inches | Screen Protector          | Protective Edge Case     |
|---------------------------------------|-----------------------|---------------------------|--------------------------|
| iPad Air M2/M3                        | 11"                   | <a href="#">DGIPDA11</a>  |                          |
| iPad Air M2/M3                        | 13"                   | <a href="#">DGIPDA13</a>  |                          |
| iPad Pro M4/M5                        | 11"                   | <a href="#">DGIPDP11</a>  |                          |
| iPad Pro M4/M5                        | 13"                   | <a href="#">DGIPDP13</a>  |                          |
| iPad 10th-11th (A16) Gen              | 10.9" / 11"           | <a href="#">DGIPMN09</a>  | <a href="#">BNDIP109</a> |
| iPad (7th-9th Gen)                    | 10.2"                 |                           | <a href="#">BNDIP102</a> |
| iPad mini (6th-7th Gen)               | 8.3"                  | <a href="#">DGIPMN06</a>  | <a href="#">BNDIPMN6</a> |
| Samsung Galaxy Tab                    |                       |                           |                          |
| Galaxy Tab A9+/A11+                   | 11"                   | <a href="#">DGSGTA9P</a>  | <a href="#">BNDTA9P</a>  |
| Galaxy Tab S9/S9FE/S10FE/S10 Lite/S11 | 10.9" / 11"           | <a href="#">DGSGTS9FE</a> |                          |
| Galaxy Tab A9/A11                     | 8.7"                  | <a href="#">DGSGTA9</a>   | <a href="#">BNDTA9</a>   |
| Samsung Galaxy Tab A8                 | 10.5"                 | <a href="#">DGSGTA8</a>   |                          |
| Microsoft Surface                     |                       |                           |                          |
| Surface Go (2nd-4th Gen)              | 10.5"                 | <a href="#">DGSGO</a>     |                          |
| Surface Pro 9-11                      | 13"                   | <a href="#">DGSPRO</a>    |                          |

COMPULOCKS

DISPLAY. SECURE. ENGAGE

### Let's Meet!

Compulocks Europe

[www.maclocks.eu](http://www.maclocks.eu)

[eu@compulocks.com](mailto:eu@compulocks.com)

Compulocks USA

[www.compulocks.com](http://www.compulocks.com)

[sales@compulocks.com](mailto:sales@compulocks.com)

### Scan to Visit Our Websites



Visit Compulocks



Visit Maclocks