

CATALOG 2026

MADE FOR APPLE

Everyday Connections, Enhanced

*Secure Mounts for iPads, MacBooks,
Mac Studio, Mac mini and Apple TV*



compulocks.com

COMPULOCKS
DISPLAY. SECURE. ENGAGE.

About Us

Compulocks is the leading design manufacturer of IT hardware security and iPad display solutions for businesses and across industries.

With an in-house R&D team and an understanding of every work environment's needs, we provide our clients with high end customer specific products that elevate their work, operations, and communications.

- Quality Assurance**
Durable materials for long-term usage
- Security Experts**
Creating security solutions for over 10 years
- International Service**
Operations in North America and Europe serving the world
- Fortune 500**
Chosen by companies from start-ups to Fortune 500

DESIGNED FOR PEOPLE, ENGINEERED FOR PERFORMANCE

Practical, secure products that streamline workflows and protect devices in any environment.





We Went ECO

Compulocks is committed to sustainability and recognize our responsibility to minimize our environmental impact. Our goal is to create innovative and secure solutions for our customers while ensuring our operations are conducted in a sustainable and ethical manner. This policy outlines our commitment to sustainability across all aspects of our business.

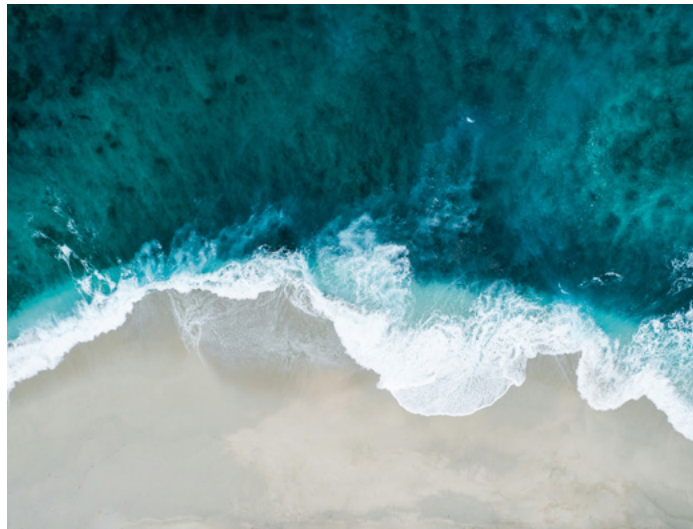

Our Renew & Recycle Program

Our Renew & Recycle Program empowers customers to return their end-of-life products, ensuring responsible recycling and repurposing.



80%

of the materials from returned products are **either recycled or repurposed**



Renew & Recycle

Stage 1

Contact Us

Email eco@compulocks.com

to get your free shipping return labels.

Stage 2

Send & Disassemble

Ship us your products, and we'll disassemble and sort materials.

Stage 3

Recycle Responsibly

Partnering with recycling companies, we ensure all parts are sustainably recycled.

Stage 4

Greener World

Together, we create a more sustainable future.

How Do You Want to Mount Your iPad?

All Compulocks iPad holders pair seamlessly with our floor, wall, or counter displays to suit any device or setup. Create your ideal combination from our versatile options.

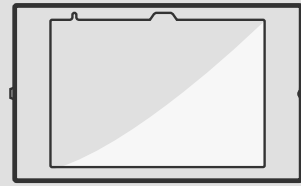

Apex



Mast Stand

Brandable Floor Stand

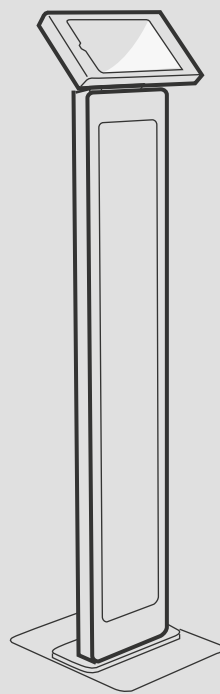

Sleek metal frame
Quick keyed access
Easy and quick installation

LEARN MORE

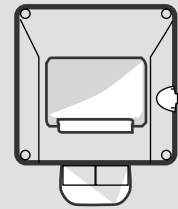

PowerMove



Wall Mount

Rise Stand

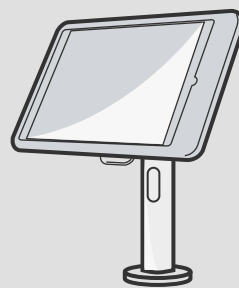
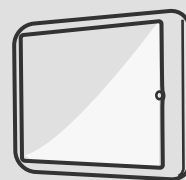

Charging display
Click on/off
Allows mobility

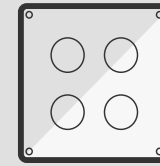

Magnetix



AV Capsule Stand

Core Stand

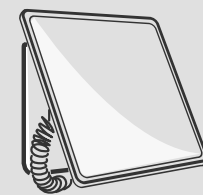

Universal
Allows mobility
Click on/off

LEARN MORE

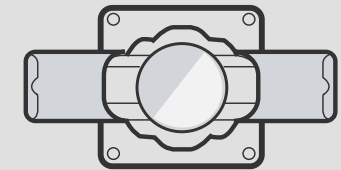

Cling



Mast Stand

Swift Floor Stand

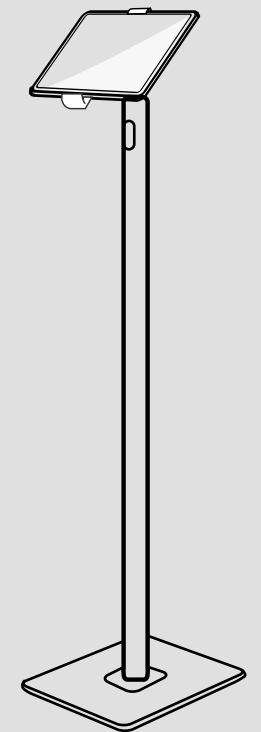

Universal
Portrait/Landscape orientation
Intuitive design

LEARN MORE



Brandable Floor Stand for Large Screens

- Max screen size and weight: 32", 9Kg/19.8lbs
- Easy installation
- 200x200 mm VESA compatible mount
- Adjustable viewing angle
- Wire management through stand
- 2mm thick polypropylene graphic panel included
- The setup allows for either free-standing base or base bolted to the floor.

[LEARN MORE](#)



Lighting Kit for the Brandable floor Stand

- Easy installation
- Full area lighting
- Efficient space management

[LEARN MORE](#)

NEW!



Swing Arm

75x75mm
VESA Mount

100x100mm
VESA Mount

AI high-grade
aluminum

Tilt & Pan

Swivel

- VESA 75x75 & 100x100 compatible
- Extends from 4.5" to 10.2" (11.5-26 cm) from the wall
- Secure & easy install
- Supports up to 4.8 lb (1.95 kg)
- Sleek, eco-conscious design
- Max Screen Size: 15"



LEARN MORE

Bow Wall Mount

75x75mm
VESA Mount

100x100mm
VESA Mount

AI high-grade
aluminum

Tilt / Pan

- Tilt or pan screen based on installation
- Secures to any flat surface
- Four cable exit options
- Easy hinge adjustment
- Portrait or landscape mountable
- Max screen size: 27"
- Supports up to 10lb / 4.5kg
- Black or white



LEARN MORE

PLAY THE VIDEO



Made from 98% recyclable aluminum with 30% recycled content, offering durable, eco-friendly protection.

NEW!



Rise Stand

75x75mm
VESA Mount

100x100mm
VESA Mount

AI high-grade
aluminum

Tilt

Swivel

The Rise Stand is a sleek, secure countertop display for iPads, compatible with 75x75mm and 100x100mm VESA mounts and all Compulocks' enclosures and universal secured iPad mounts. Its wide tilt range and clean cable routing make it ideal for retail, hospitality, and POS use. Built with durable materials, it's available in two pole heights to fit any counter layout.

LEARN MORE

VESA Stand with Cable Management



Swivel and tilt



75x75mm and 100x100 mm
VESA-compatible mount



Two heights
4"/10 cm or 8"/ 20 cm



Cable management
through pole

- VESA 100mm x 100mm and 75mm x 75mm compatible
- Allows continuous charging while the device is mounted
- Two stand height options
- Swivel and tilt head
- Supports up to 10lb / 4.5kg
- Built-in cable management
- Works with our security cable lock
- Max Screen Size: 20"



Optional bases available
Adhesive Stability Base for the Rise
Stand (**STB3B**)

NEW!



Swift Floor Stand

75x75mm VESA Mount

100x100mm VESA Mount

AI high-grade aluminum

Tilt

lightweight

The Swift Floor Stand is a lightweight, durable aluminum display built for easy setup and mobility. Ideal for trade shows, pop-ups, and retail spaces, it assembles with a single screw and includes floor-mount and cable lock options for secure installation.

LEARN MORE

PLAY THE VIDEO

Quick Setup, Best Value Pricing



Tilting mount



75x75mm and 100x100 mm VESA-compatible mount



Freestanding or floor-mountable with four screws

- 75x75mm and 100x100 mm VESA-compatible mount
- Supports monitors up to 15.6" and 11lb (5kg)
- Stands 3.1 ft (95.5 cm) tall
- Large cable openings for easy cable management
- Can be used freestanding or secured with four screws

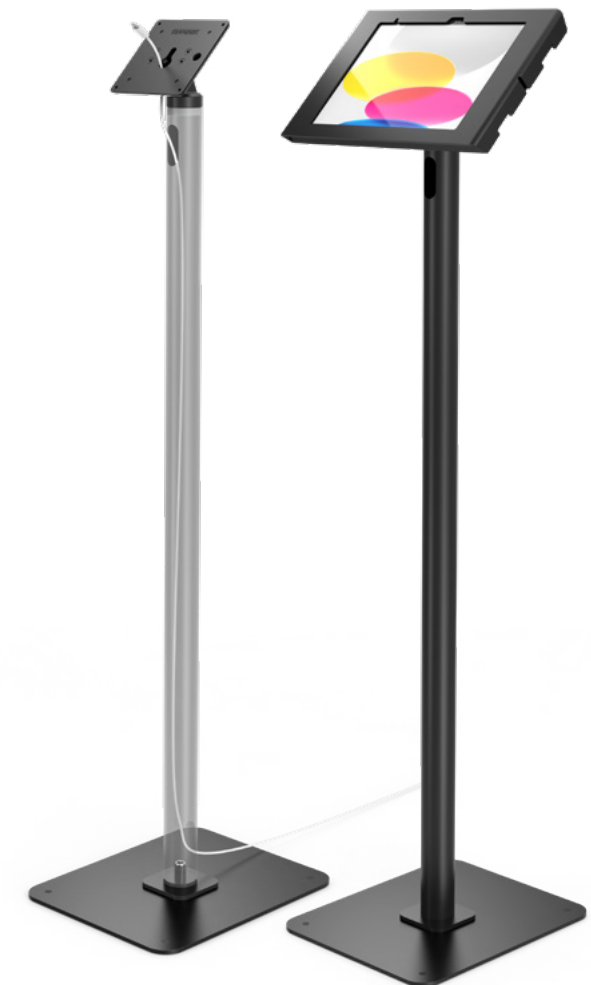

Large cable openings for streamlined integration

NEW!



Secure Locking Mechanism



Powerful USB-C Charging System



Spacious & Device-Friendly Slots



Easy Monitoring

Charging & Locking Cabinet

Lock & Recharge all devices at once, easily

The Charging & Locking Cabinet for 16 Notebooks & Tablets securely stores, charges, and organizes laptops, Chromebooks, iPads, up to 15.6". Built with durable, high-performance materials and a compact design, it's ideal for educational, business, and public settings.

LEARN MORE

PLAY THE VIDEO

Charging & Locking Cabinet for 16 Notebooks & Tablets USB-C PD 3.0 (Up to 1000W)

- Powerful USB-C charging system
- Spacious & device-friendly slots
- Easy monitoring
- Rugged, durable construction
- Wall-mountable for space efficiency
- Active ventilation system
- Security mechanism with combination lock and backup key
- 1000W total / max 100W per port
- 16 USB-C cables with 90° connector are included.

WALL DISPLAYS



Wall Displays



Portrait or Landscape installation



Made from 98% recyclable aluminum with 30% recycled content, offering durable, eco-friendly protection.

Apex

100x100mm VESA Mount | 75x75mm VESA Mount | Compatible 

- Sleek metal frame
- Quick Lock / Unlock Keyed Mechanism
- Option for direct wall mounting
- Exposed front and back cameras and sensors
- Conceals charging cable
- Compatible with all Compulocks' VESA stands and mounts

[LEARN MORE](#)



Portrait or Landscape installation

Swell

Compatible  100x100mm VESA Mount | 75x75mm VESA Mount



Made from 98% recyclable aluminum with 30% recycled content, offering durable, eco-friendly protection.

- Metal construction for extra durability
- Closed and minimal design for maximum protection of the iPad
- Tamperproof screws
- Exposed front and back cameras including sensors
- Conceals charging cable
- Compatible with all Compulocks' VESA stands and mounts

[LEARN MORE](#)

Space

Compatible  100x100mm VESA Mount



Portrait or Landscape installation

- High-grade aluminum enclosure with rounded edges
- Quick Lock / Unlock Keyed Mechanism
- Conceals charging cable
- Designed to expose cameras and sensors
- Compatible with all Compulocks' VESA stands and mounts



Made from 98% recyclable aluminum with 30% recycled content, offering durable, eco-friendly protection.

[LEARN MORE](#)

WALL DISPLAYS



IT Mount Bow Tilting Wall Mount NEW!

100x100mm VESA Mount **Compatibility: Universal**

- Tilt or pan screen
- Four cable exit options
- Easy hinge adjustment
- Fits to any flat wall
- Industrial strength stick pads
- Max Load: 5lb / 2.27kg
- Max Screen Size: 13" / 33cm
- Tamper-proof screws
- Can be repurposed and used again on other displays, using a new set of sticker pads

[LEARN MORE](#)

Cling Wall Mount

100x100mm VESA Mount **Compatibility: Universal**

- Universal, compatible with iPads 7" - 13", Max thickness: 9.3mm
- Max Load: 5lb / 2.27kg
- Rotates between portrait and landscape orientations
- Tamperproof design
- Secure cable management

[LEARN MORE](#)



Wall Displays

Magnetix Wall Mount

100x100mm VESA Mount **Compatibility: Universal**

- Universal mount system for all iPads
- For displays and handheld use, cable lock secured
- Easily switch between landscape and portrait orientations
- Max Load: 5lb / 2.27kg
- Max Screen Size: 13" / 33cm
- Compatible with all Compulocks' VESA stands and mounts

[LEARN MORE](#)

[PLAY THE VIDEO](#)

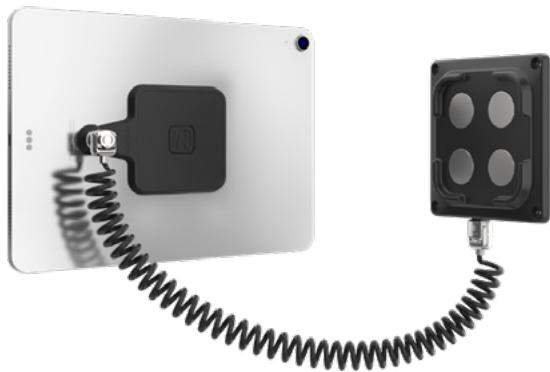

Apex Enclosure Swing Wall Mount NEW!

Compatible 

- Sleek metal frame
- Quick Lock / Unlock Keyed Mechanism
- Extends from 4.5" to 10.2" (11.5-26 cm) from the wall
- Tilt, pan, and swing for multiple display angles
- Secure & easy install
- Supports up to 4.8 lb (1.95 kg)

[LEARN MORE](#)



Counter Stands

Made with high-quality materials, our iPad kiosk stands have a harmonious design, advanced security features, and are easy to install. They are adaptable to all types of environments. They ensure a perfect fit no matter the size, make, or model.



Made from 98% recyclable aluminum with 30% recycled content, offering durable, eco-friendly protection.

Apex Enclosure Core Stand

Compatible

- Powder-coated steel stand
- Enclosure can be set in landscape or portrait orientation
- Wall or countertop mountable
- Add-on adhesive and Swivel bases

[LEARN MORE](#)



Swell Enclosure Mast Stand

Compatible

- Metal construction for extra durability
- Full reverse tilt
- Cable management
- Tilt tension screws
- Optional Stability base add-on

[LEARN MORE](#)



Glidetab Lock Stand NEW!

Compatibility: Universal

- Universal iPad stand
- Portrait or landscape orientation
- Keyed lock for easy removal
- 60° table top viewing angle
- Countertop or wall-mounted setup

[LEARN MORE](#)

[PLAY THE VIDEO](#)

COUNTER STANDS



iPad Printer Kiosk

[PLAY THE VIDEO](#)

100x100mm VESA Mount | 75x75mm VESA Mount

COMPATIBILITY **EPSON** **star**

Compatible

- Securely mount a variety of iPads
- Sturdy, high-quality iPad holder
- Printer dimensions - H- 160 mm / 6.3 in, W- 130 mm / 5.12 in, D- 150 mm / 5.91 in
- Base can be securely bolted onto the countertop
- Embedded and removable stability base for a freestanding setup
- Max Load: 5.51lb / 2.5 kg
- Max Screen Size: 15"

[LEARN MORE](#)



Made from 98% recyclable aluminum with 30% recycled content, offering durable, eco-friendly protection.



Secured KickStand

Compatible

- Metal kickstand for durability
- 6ft Keyed Cable lock included
- Dual angle - 7.5° and 30° stances
- Rubber feet for stability and traction
- Easy installation with 3M VHB pads

[LEARN MORE](#)

[PLAY THE VIDEO](#)

Screen tilt & swivel



Apex Rise Stand

Compatible

- 2 Height options available
- Through arm cable management
- Swiveling and tilting mount head
- Optional adhesive and freestanding bases

[LEARN MORE](#)

Ideal for video conference management



Apex AV Capsule Stand

Compatible

- Concealed storage space for cables and battery
- 30° table top, 60° wall mounted viewing angle
- Built-in cable lock slot

[LEARN MORE](#)



Made from 98% recyclable aluminum with 30% recycled content, offering durable, eco-friendly protection.



Floor Stands

Made with high-quality materials, our Floor stands have a harmonious design, advanced security features, and are easy to install. They are adaptable to all types of environments. They ensure a perfect fit no matter the size, make, or model.



Swift Floor Stand NEW!

100x100mm VESA Mount | 75x75mm VESA Mount

- Supports monitors up to 15.6" and 11lb (5kg)
- Stands 3.1 ft (95.5 cm) tall
- Large cable openings for easy cable management
- Can be used freestanding or secured with four screws

[LEARN MORE](#)

[PLAY THE VIDEO](#)

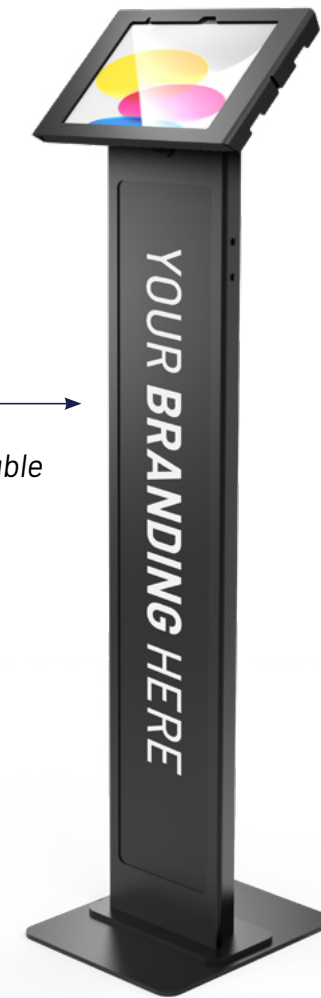

Brandable panel

Brandable Floor Stand

100x100mm VESA Mount | 75x75mm VESA Mount

- Panel for branding, call to action, or custom design
- Internal lighting option for backlit branding
- Tilting mounting plate
- Cable management for charging while mounted
- Concealed storage space for adaptor, batteries, etc.

[LEARN MORE](#)



ROLLING STANDS

Rolling Stands

Make any iPad a mobile, hands-free workstation for bedside care.

Our rolling stands combine VESA compatibility, adjustable height and viewing angles, integrated cable management, and a lockable battery box to protect power and data. A work shelf, storage basket, and locking wheels keep devices and supplies organized and stable in busy clinical environments.

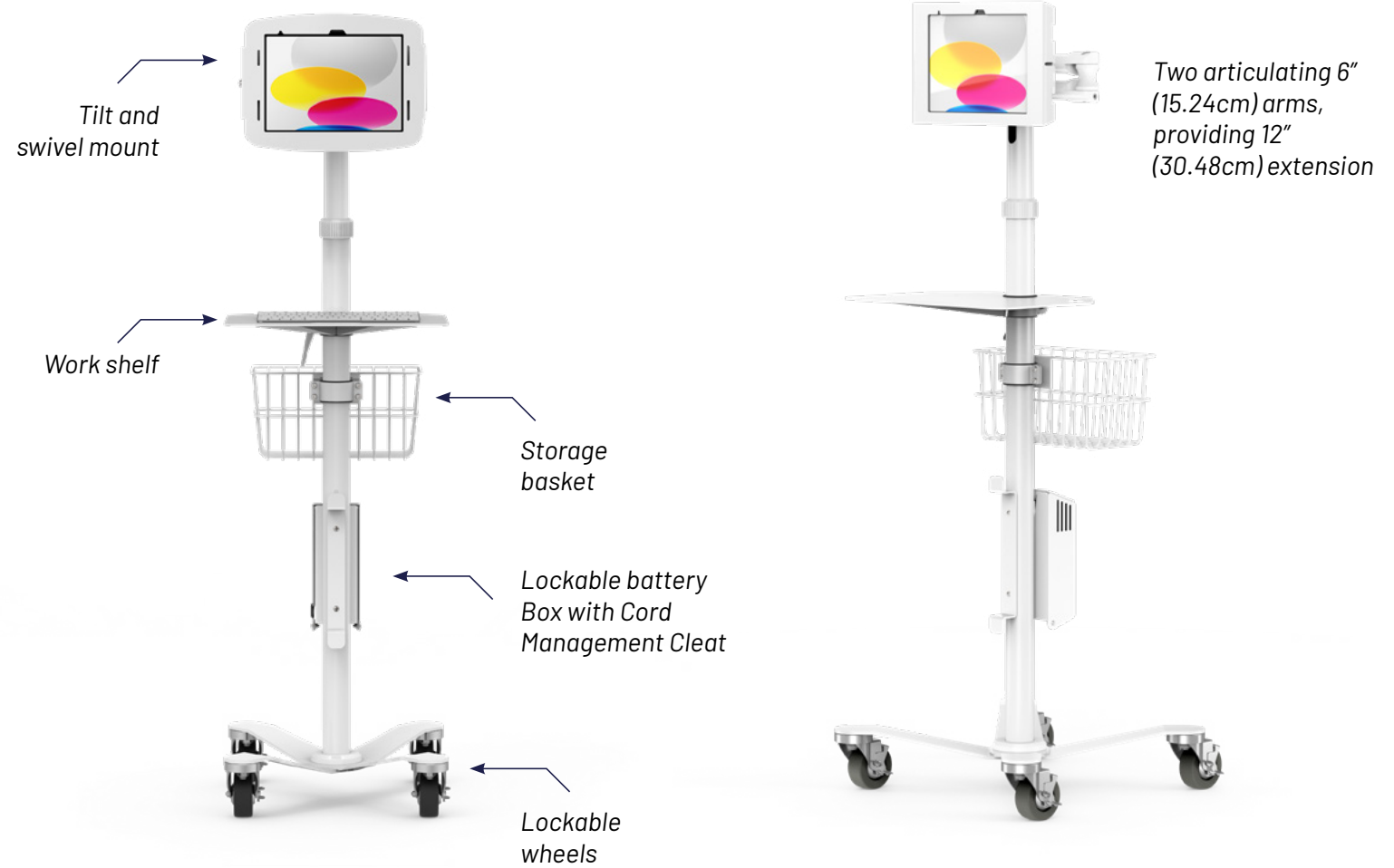

Tablet Rolling Cart

100x100mm VESA Mount | 75x75mm VESA Mount

- Dynamic, rolling, hands-free workstation
- Through pole cable management
- Adjustable height and viewing angles
- Rolls easy and fits in tight spaces
- Perfect for healthcare and medical settings

[LEARN MORE](#)

[PLAY THE VIDEO](#)

Premium Tablet Rolling Cart

100x100mm VESA Mount | 75x75mm VESA Mount

- Locking wheels for smooth, secure mobility
- Heavy-duty base for added stability
- Dual-jointed arm extends up to 12"
- Adjustable tilt with secure angle lock
- 1-screw assembly for fast setup
- Clean cable routing with pass-through

[LEARN MORE](#)

[PLAY THE VIDEO](#)



Other Mounts

Glass Mount

100x100mm
VESA Mount

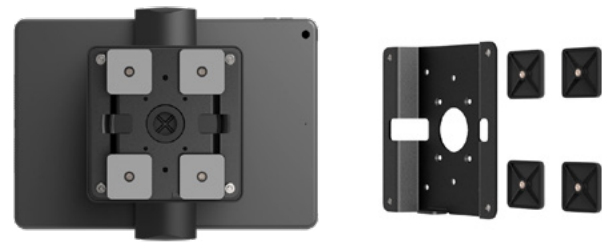

- Securely mount any iPad on smooth surfaces including marble and glass; no drilling required
- Easy to install and can be removed using a dedicated tool (supplied separately)
- Powerful VHB adhesive pads to fix to glass and other smooth surfaces
- Max Load 4.4lb / 2kg
- Max Screen Size: 13"

[LEARN MORE](#)



Rail Mount

100x100mm VESA Mount | 75x75mm VESA Mount

- Fix to rails 12.7mm (0.5") Ø to 38.0mm (1.50") Ø
- 340° screen swivel
- 125° screen flip
- Max Load: 10lb / 4.5kg
- Max Screen Size: 15"

[LEARN MORE](#)





Apple Mounts



Apple TV Security Mount

Compatible with all Apple TV models

- Easy fix to any flat surface
- Lightweight and low profile
- Ventilated aluminium construction
- Security slot for lockhead or cable lock

LEARN MORE

Best Seller



Made from 98% recyclable aluminum, including 30% recycled content for durable, eco-friendly protection.



Mac mini Security Mount

Compatible with all Mac mini models

- Lightweight and low profile
- High-grade aluminum construction
- 100x100mm and 75x75mm VESA Mounting Pattern
- Security slot for lockhead or cable lock

LEARN MORE

Best Seller



Built from 98% recyclable aluminum with 70% recycled content for strong, sustainable protection.



Made from 98% recyclable aluminum, including 70% recycled content for durable, eco-friendly protection.

Mac Studio Locks

Mount | 100x100mm VESA Mount

- Secures directly to a flat surface or freestanding secured with cable lock
- Additional T-Bar lock slot for peripheral
- Ventilated design
- Unrestricted access to ports

LEARN MORE

Ledge Lock

- Unique Ledge lock adapter mechanism
- Creates accessible T-Bar lock slot compatible with standard cable locks
- Non-invasive
- Low profile solution

LEARN MORE



Stand

- Mac Studio secured with cable lock to stand or fixed point
- Increases ventilation and decreases dust accumulation
- Allows use of standard T-Bar cable locks
- Maintains small footprint
- Additional T-Bar lock slot for peripheral

LEARN MORE



PLAY THE VIDEO 



Mobility. Connectivity. Security.



The keyed lock keeps your iPad secure in any environment, while built-in pogo pins ensure continuous charging and data transfer.

PowerMove

PowerMove is an all-in-one solution for USB-C iPads, providing constant charging, data transfer, and easy mobility with its Lift-to-Release mechanism. Compatible with Compulocks counter, VESA wall, and floor stands.

Streamline Your Operations

Ideal for any industry—from customer service and warehousing to quality control and on-the-go sales.

LEARN MORE

PowerMove Features

100x100mm
VESA Mount

- Pogo pins for connectivity and charging
- Allows data and power transfer through USB-C interface
- Locking mechanism for iPad security
- Direct charging port when detached from dock
- Rugged case available for iPad 10-11 Gen, Galaxy Tab A9+, and Galaxy Tab A11+
- Easy to use “lift to release” mechanism
- Integrated security slot, USB-C charging port and kickstand on iPad back side





Plus Hub

The Plus Hub is a multi-functional media add-on that enhances iPad connectivity. Designed for Compulocks counter, wall, and floor stands, it offers a sleek, organized solution for managing connections.

Group your cables and ports for a clean, efficient, and professional workspace.

[LEARN MORE](#)

[PLAY THE VIDEO](#)



Connectivity Reimagined



Connect your iPad to a display, printer, scanner, or keyboard for seamless presentations and productivity – the Plus Hub makes every connection simple and efficient.



The Plus Hub Features

100x100mm
VESA Mount

- Hub ports specification : USBPD, USB-C, HDMI, 2xUSB-A, RJ45
- Allows data and power transfer through USB-C interface
- Ventilation holes incorporated to ensure proper temperature regulation
- Option for direct wall mounting

Compatibility

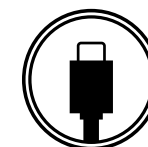

Compatible with all products with a USB-C port



Ergonomic Arm

100x100mm VESA Mount | 75x75mm VESA Mount

- Wide range of motion: tilt, swing, and pan
- Clamp-on, mount through desk or wall mount
- Cable management keeps all wires and cords

LEARN MORE

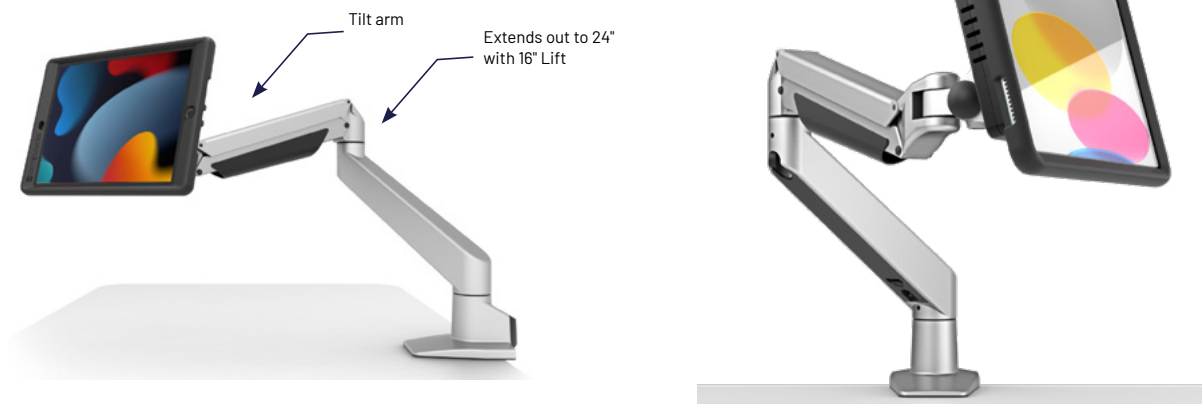

MacBook Ledge Lock

Since MacBook Pro and Air models lack built-in security slots, Compulocks offers exclusive "Ledge" T-Slot adapters for each model.

- Models compatible with all MacBook Pro and Air
- Compatible with standard T-Bar cable locks
- Cutting-edge design for maximum security
- Small size and weight

LEARN MORE





Lock Adapters & Cable Locks



Universal Tablet Lock

Compatible: Universal

- Low-profile Universal Security Plate
- 3M VHB industrial adhesive
- 6ft galvanized steel cable lock
- Loop-ended cable for easy tethering

LEARN MORE

Best Seller



Blade Universal Lock

Compatible 

- Universal for any device
- Extremely durable
- Compatible with standard T-bar cable lock
- Retractable "Blade" security slot

LEARN MORE



Keyed Cable Lock

6ft Universal T-Bar Keyed Cable Lock

LEARN MORE



Combination Cable Lock

6ft Universal T-Bar Combination Cable Lock

LEARN MORE



Dual cable lock

Dual-Headed Keyed Coiled Cable Lock

LEARN MORE

Did You Know?

The FBI's National Crime Information Center estimates that each year up to 800,000 memory devices (MacBooks, iPads, etc.) are lost or stolen. Due to their value, securing MacBooks, laptops, and iPads is more urgent than ever.

*Source: forbes.com



Universal Hand Grip



POS Terminal Solutions

EMV SlideDock Security Stand

- Universal device security stand
- Quick connect docking plate
- Counter-top or wall mountable
- Simple, stylish, and secure
- Comes with VHB pad and swivel base

[LEARN MORE](#)



Hand Grip

- Universal to fit all iPads
- Adjustable strap for a comfortable fit, even with gloves
- Industrial-strength adhesive
- 360 degree screen rotation

[LEARN MORE](#)

Grip & Dock Station

- Secured 'grab and go' iPad stand
- Quick keyed lock and release system
- Wall or countertop mount

[LEARN MORE](#)

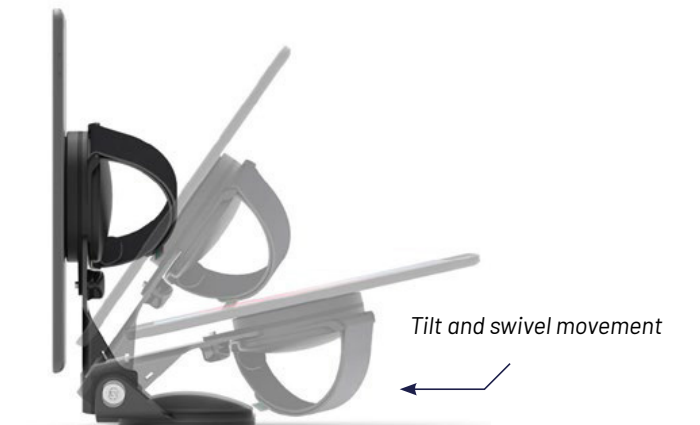



Store & Charge

Charging & Locking Cabinet

[LEARN MORE](#)

- Powerful USB-C charging system
- Secure locking mechanism
- Spacious & device-friendly slots
- Easy monitoring
- Rugged, durable construction
- Wall-mountable for space efficiency
- Active ventilation system

USB Charging Dock

- Ideal for iPads
- 5 ports USB charging hub - USB/USBC
- Multi-protection over temperature, voltage, and short circuit
- Worldwide compatibility

Protective Solutions

Edge Case

[LEARN MORE](#)

Rugged silicone protection

- Rubberized for a firm grip and protection
- Cutouts for buttons, ports, and cameras
- Open back area for universal adhesive locking mechanisms

Screen Shield

[LEARN MORE](#)

Tempered glass screen protector

- Shatterproof and scratch-resistant
- Maintains touchscreen sensitivity
- Crystal clear image resolution
- Nano-coating to repel finger marks and dust

Your Vision, Perfected

At Compulocks, we offer customized iPad mounting solutions. Trust us to take your ideas and transform them into something extraordinary.

LEARN MORE

Integration

Craft one-of-a-kind devices with modified enclosures for multiple gadgets.

Branding

Personalize your solution with your logo and company colors.

Sizing

Customize a unique size that isn't typically available in our lineup.

Functionality

Enhance your enclosure with additional screws and custom slots.

Get Some Design Inspiration From Other Customers



Healthcare Translations

Learn More >>



On-the-Go POS

Learn More >>



NFC for Schools

Learn More >>

Compulocks bespoke iPad printer kiosks bring **brand presence** to leading food service enterprise



Featuring a universal 100x100mm and 75x75mm VESA mount plus a retail-sized printer housing, the POS Printer Kiosk is designed for the fast-paced needs of restaurants and eateries.

This custom kiosk streamlines order processing and elevates customer interaction. Each unit can be branded with signature colors, creating a vibrant, cohesive presence in any establishment.

Swell and Apex Enclosures

Apple iPad	Screen Size in Inch	Swell Enclosure
iPad 10th-11th (A16) Gen	10.9" / 11"	209SWLB
		Apex Enclosure
iPad 10th-11th (A16) Gen	10.9" / 11"	209APXB
iPad Air M2/M3	11"	11APXB
iPad Air M2/M3	13"	13APXB
iPad Pro M4/M5	11"	11PAPX4B
iPad Pro M4/M5	13"	13PAPX4B

Space Enclosures

Apple iPad	Screen Size in Inch	Space Enclosure
iPad (7th-9th Gen)	10.2"	102IPDSB
iPad mini (6th-7th Gen)	8.3"	830IPMSB

PowerMove

Apple iPad	Screen Size in Inches	PowerMove
iPad 10th-11th (A16) Gen	10.9" / 11"	PMIP109

Apple Mounts

Apple TV	Security Mount			
Apple TV 4K (3rd Gen)	ATVEN43			
Apple TV 4K (1st-2nd Gen)	ATVEN35			
Mac mini				
Mac mini M4	MMEN24			
Mac mini M1/M2	MMEN76			
Mac Studio	Lock adapter	Lock adapter with key lock	Bracket Mount	Desktop Stand
Mac Studio	MSLDG01	MSLDG01KL	MSBKT01	MSSTD01

Apple Locks

Apple MacBook	Ledge Lock Adapter	Lock Adapter With Key Lock	Lock Adapter with Combination Lock
MacBook Pro/Max 16-inch (M1/M2/M3/M4)	MBPR16LDG02	MBPR16LDG02KL	MBPR16LDG02CL
MacBook Pro/Max 14-inch (M1/M2/M3/M4/M5)	MBPR14LDG01	MBPR14LDG01KL	MBPR14LDG01CL
MacBook Air 15-inch (M2/M3/M4)	MBALDG05	MBALDG05KL	MBALDG05CL
MacBook Air 13-inch (M2/M3/M4)	MBALDG04	MBALDG04KL	MBALDG04CL
		Blade Bracket	Blade Bracket with keyed lock
All MacBooks	BLD01	BLD01KL	BLD01CL

Security KickStand

Apple iPad	Screen Size in Inches	Security KickStand
iPad 10th-11th (A16) Gen	10.9" / 11"	109KS01KL
iPad (7th-9th Gen)	10.2"	102KS01KL
iPad Mini (6th-7th Gen)	8.3"	830KS01KL











Protective Accessories

Apple iPad	Screen Size in Inches	Screen Protector	Protective Edge Case
iPad Air M2/M3	11"	DGIPDA11	
iPad Air M2/M3	13"	DGIPDA13	
iPad Pro M4/M5	11"	DGIPDP11	
iPad Pro M4/M5	13"	DGIPDP13	
iPad 10th-11th (A16) Gen	10.9" / 11"	DGIPMN09	BNDIP109
iPad (7th-9th Gen)	10.2"		BNDIP102
iPad mini (6th-7th Gen)	8.3"	DGIPMN06	BNDIPMN6

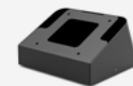
Universal Solutions

									
Solution	Glidetag	Grip & Dock	Universal Tablet Lock	Secured EMV Stand	Universal Tablet Holder	Solutions with Cling	Solutions with IT-mount	Solutions with Magnetix	Tablet Rugged Case Stand
Part #	GLDTABB	189BGRPLCK	CL15UTL	199BSLDDCKB	CL12UTHBB	UCLGVWMB	SMP01B	VHBMM01	820BRCH

Stands and Wall Mounts

										
Solution	Mast Stand	Fixed 45° - Core Stand	Tilting 8" Counter Stand - Rise	Tilting 4" Counter Stand - Rise	AV Conference Room Capsule	Tablet Printer Kiosk	Articulating Arm Mount - Reach	Flexible Counter Stand - Flex Arm	Tilting Wall Mount - Bow	Swing Wall Mount - Swing
Part #	333B	111B	TCDP01	TCDP04	341B	PK01	660REACH	159B	505B	827B

Stands

								
Solution	Brandable Floor Stand - BrandMe	Swift Floor Stand	Brandable VESA Floor Stand for Screens Up to 32 Inches	Brandable VESA Floor Stand for the Samsung E-Paper	VESA Brandable Floor Stand with Lighting Kit UK Power Cord	VESA Brandable Floor Stand with Lighting Kit EU Power Cord	Premium Rolling Cart	Rolling Cart - Rise Freedom
Part #	140B	150B	140BLBPB	140B200LBPB	140BLK01-UK	140BLK01-EU	170W	MCRSTDW

COMPULOCKS

DISPLAY. SECURE. ENGAGE

Let's Meet!

Compulocks Europe

www.maclocks.eu

eu@compulocks.com

Compulocks USA

www.compulocks.com

sales@compulocks.com

Scan to Visit Our Websites



Visit Compulocks



Visit Maclocks