

**MADE FOR APPLE**

# COMPULOCKS

DISPLAY. SECURE. ENGAGE.



**Catalog 2025**

**EVERYDAY CONNECTIONS,  
ENHANCED**

[compulocks.com](https://compulocks.com)

# ABOUT US

Compulocks is the leading design manufacturer of IT hardware security and iPad display solutions for businesses and across industries.

With an in-house R&D team and an understanding of every work environment's needs, we provide our clients with high end customer specific products that elevate their work, operations, and communications.



Quality Assurance

Durable materials for long term usage



Security Experts

Creating security solutions for over 10 years



International Service

Operation in North America and Europe serving the world

FORTUNE 500

Fortune 500

Chosen by companies from start-up to Fortune 500

## In 2025, our focus is on reinvention.

With our design and engineering experience, we are committed to **improving the way people work.**

We are launching new products that enhance connectivity and enable advances in technology to benefit every workplace.





## WE'RE GOING ECO

At Compulocks, we are committed to sustainability and recognize our responsibility to minimize our environmental impact. Our goal is to create innovative and secure solutions for our customers while ensuring our operations are conducted in a sustainable and ethical manner. This policy outlines our commitment to sustainability across all aspects of our business.



## Our Commitment

Compulocks is dedicated to:

---

Sustainable Product Design

---

Ethical Sourcing

---

Waste Management

---

Energy Efficiency

---

Environment and Regulation

---

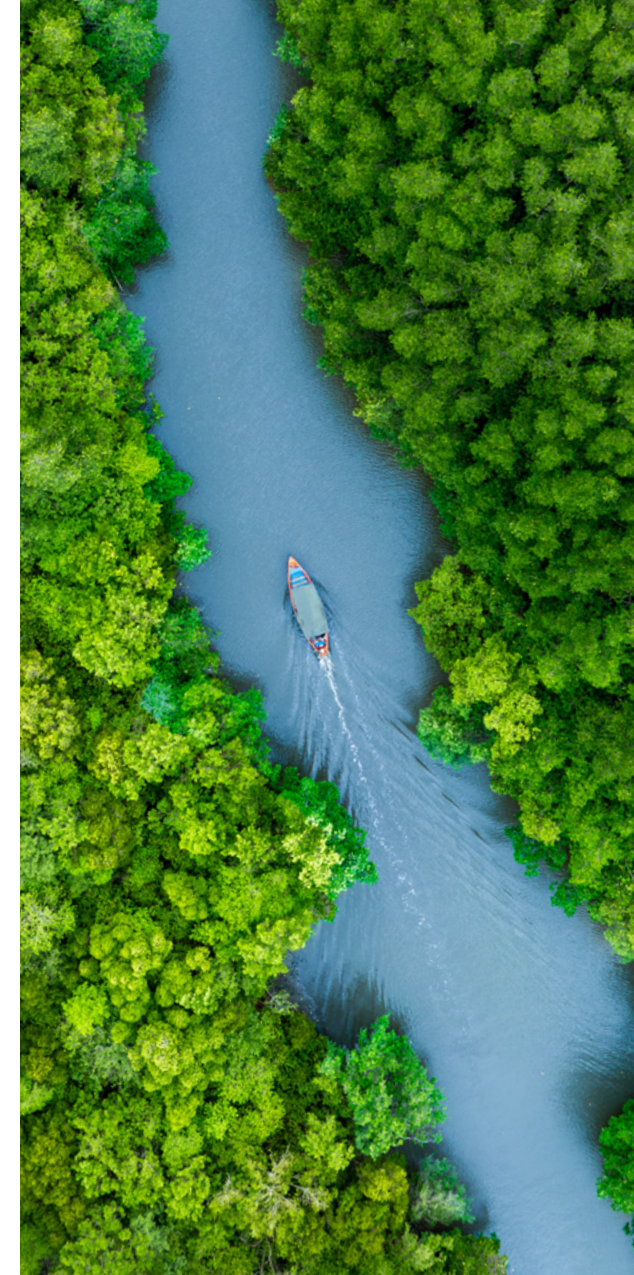

*We prioritize the design and development of products that are durable, repairable, and recyclable.*



We make it easy to go green with our Renew & Recycle Program. Here's how it works, from start to finish.

# RENEW & RECYCLE

## Our New Eco Program

At Compulocks, we are committed to sustainability at every stage of our product lifecycle, including the end-of-life phase. Our Renew & Recycle Program empowers customers to return their end-of-life products, ensuring responsible recycling and repurposing.

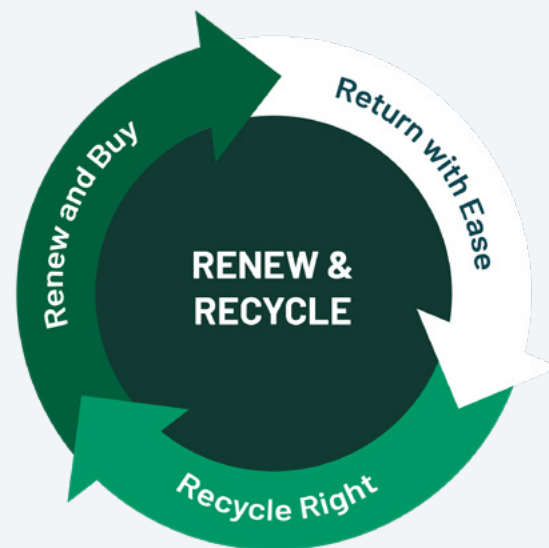

### Stage 1

#### Contact Us

Email [eco@compulocks.com](mailto:eco@compulocks.com) to get your free shipping return labels.

### Stage 3

#### Recycle Responsibly

Partnering with recycling companies, we ensure all parts are sustainably recycled.

### Stage 2

#### Send & Disassemble

Ship us your products, and we'll disassemble and sort materials.

### Stage 4

#### Greener World

Together, we create a more sustainable future.



Over 80% of the materials from returned products are **either recycled or repurposed**, minimizing waste and supporting environmental stewardship. To further encourage participation, we offer **free shipping** from the customer's location to our warehouse, making it easy and cost-effective to contribute to a greener future.

# HOW DO YOU WANT TO MOUNT YOUR IPAD?

All Compulocks iPad holders can be paired with any of our floor, wall, or counter displays to fit every iPad and use case.

Compulocks allows you to create your best combination. Here are a few examples:

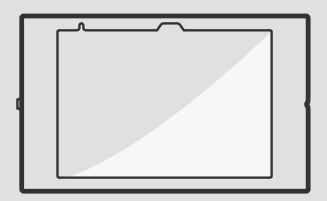

Apex

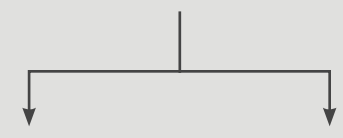

Mast Stand

BrandMe Floor Stand

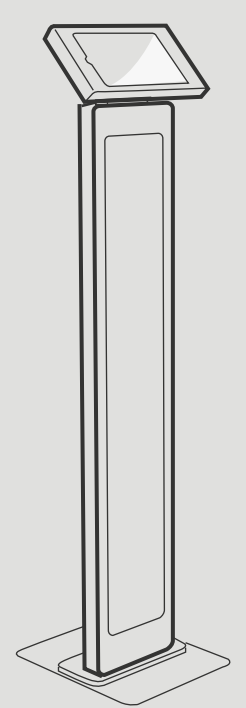

Sleek metal frame  
Quick keyed access  
Easy and quick installation

LEARN MORE

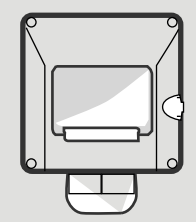

PowerMove

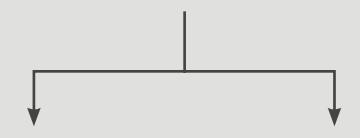

Wall Mount

Rise Stand

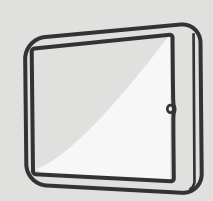

Charging display  
Click on/off  
Allows mobility

LEARN MORE

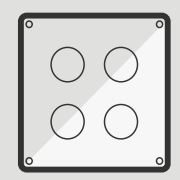

Magnetix



AV Capsule Stand

Core Stand

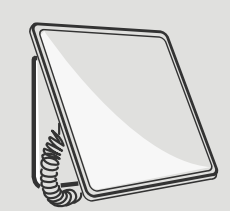

Universal  
Allows mobility  
Click on/off

LEARN MORE

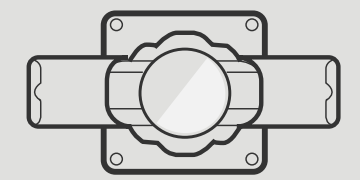

Cling



Mast Stand

Portable Stand

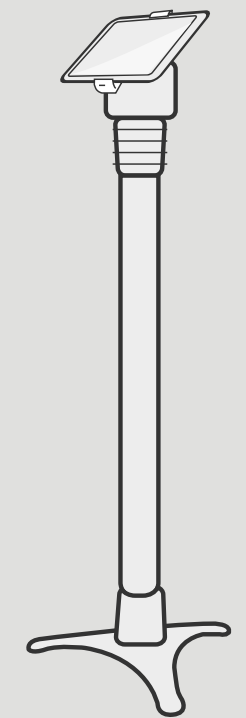

Universal  
Portrait/Landscape orientation  
Intuitive design

LEARN MORE

NEW!



## Our Updated Apple Solution MAC MINI SECURITY MOUNT

Discrete, sleek security for any workspace

Apple's Mac mini M4 is a game-changer for compact performance and efficiency. Compulocks offers a sleek, secure, and easy-to-install Mac mini mount designed to complement this innovation.

The Mac mini mount is made of lightweight, high-grade aluminum and secured with a keyed lock.

LEARN MORE

## ELEVATE YOUR DESKTOP

Crafted from high-grade aluminum, our Mac mini mount is not only lightweight but also offers robust security with a keyed lock. It's fully compatible with the M4 Mac mini model, ensuring your device is safely mounted and ready to power your next level of work.



## MAC MINI SECURITY MOUNT

Lock it up or take it to go, as needed.

75x75mm  
VESA Mount

100x100mm  
VESA Mount

AI high-grade  
aluminum

ECO

- Lightweight and low profile
- High-grade aluminum construction
- Ventilated Sides
- Easy to install
- Secured with the keyed lockhead or loop-ended keyed cable lock
- Compatible with all Mac mini models



Our new Mac mini Security Mount is **made from 98% recyclable aluminum**. Within this composition is **70% recycled aluminum**, ensuring a strong, sturdy design that provides reliable protection while also prioritizing environmentally friendly materials.

NEW!



## MEET THE BOW WALL MOUNT

Our ADA-Compliant Solution

The Bow Wall Mount supports up to 27-inch screens and secures to any flat surface – wall or countertop. It's fully ADA-compliant and tilts or pans for comfort, ideal for interaction in a wide range of environments.

LEARN MORE



### SECURE DISPLAYS FOR WALL OR COUNTER

The Bow is compatible with all of our enclosures and includes built-in cable management for a streamlined setup. Crafted from high-grade aluminum, it's available in black or white models.

### BOW WALL MOUNT

Through cable management

75x75mm  
VESA Mount

100x100mm  
VESA Mount

AI high-grade  
aluminum

Tilt

- Tilt or pan screen
- Secures to any flat surface
- Four cable exit options
- Plate lock slot
- Easy hinge adjustment
- Portrait or landscape mountable
- Max screen size: 27"
- Black or white



NEW!

# COMPULOCKS GO BIG



## BRANDME FLOOR STAND FOR LARGE SCREENS

- Brandable with custom panel
- Max screen size and weight: 32", 9Kg / 19.8lbs
- Fully tiltable, landscape or portrait mode

[LEARN MORE](#)



## LIGHTING KIT FOR THE BRANDME STAND

- Easy installation
- Full area lighting
- Efficient space management

[LEARN MORE](#)



NEW!



## IPAD PRINTER KIOSK

The iPad Printer Kiosk is a iPad holder featuring a secure housing for a retail-sized printer - an indispensable asset for any fast-paced retail, hospitality, or business environment.

LEARN MORE

## FIT FOR ANY BUSINESS

Equipped with a universal 100X100 VESA mount, the POS Printer Kiosk is compatible with a wide range of Compulocks iPads enclosures and mounts, ensuring seamless integration with your existing devices.

The kiosk's standard size accommodates most printers used in the retail and hospitality industries, offering unparalleled convenience and functionality.



## IPAD PRINTER KIOSK FEATURES

- 100X100 VESA compatibility
- Securely mount a variety of iPads
- Sturdy, high-quality iPad holder
- Printer dimensions - H- 160 mm / 6.3 in, W- 130 mm / 5.12 in, D- 150 mm / 5.91 in
- Secures onto the counter



The kiosk is made from **98% recyclable aluminum**. Within this composition is **30% recycled aluminum**, ensuring a strong, sturdy design that provides reliable protection while also prioritizing environmentally friendly materials."



## WALL DISPLAYS

Create a comfortable and functional space to display important information with wall mounts and enclosures from Compulocks. These universal iPad wall mounts with locks are easy to install on any VESA-compatible stand and come with a cable management system for a clean look while charging.

Portrait or Landscape Orientation



The enclosure is made from **98% recyclable aluminum**. Within this composition is **30% recycled aluminum**, ensuring a strong, sturdy design that provides reliable protection while also prioritizing environmentally friendly materials.

### Apex

100x100mm VESA Mount

75x75mm VESA Mount



Compatible



- Sleek metal frame
- Quick keyed access
- Option for direct wall mounting
- Exposed front and back cameras and sensors

[LEARN MORE](#)

Portrait or Landscape Orientation



The enclosure is made from **98% recyclable aluminum**. Within this composition is **30% recycled aluminum**, ensuring a strong, sturdy design that provides reliable protection while also prioritizing environmentally friendly materials.

### Swell

100x100mm VESA Mount

75x75mm VESA Mount



Compatible



- Metal construction for extra durability
- Closed and minimal design for maximum protection of the tablet
- Tamperproof screws
- Exposed front and back cameras including sensors

[LEARN MORE](#)

Portrait or Landscape Orientation

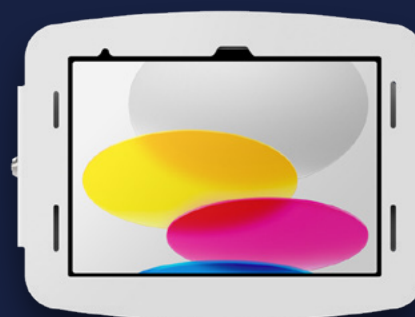

The enclosure is made from **98% recyclable aluminum**. Within this composition is **30% recycled aluminum**, ensuring a strong, sturdy design that provides reliable protection while also prioritizing environmentally friendly materials.

### Space

100x100mm VESA Mount



Compatible



- High-grade aluminum enclosure with rounded edges
- Quick keyed access
- Conceals charging cable
- Designed to expose cameras and sensors

[LEARN MORE](#)



## WALL DISPLAYS

Compulocks wall displays are compatible with every iPad made by Apple.

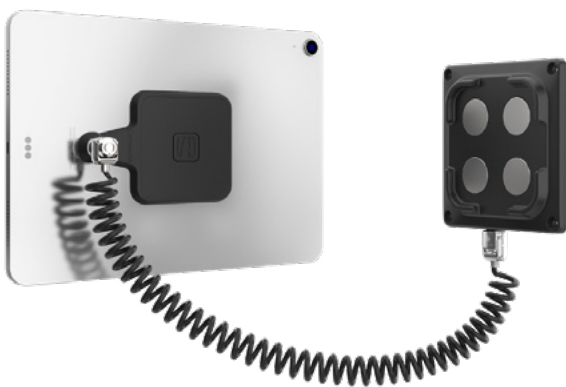

### Magnetix Wall Mount

Compatible    **100x100mm VESA Mount**

- Universal mount system for all iPads / tablets
- For displays and handheld use, cable lock secured
- Easily switch between landscape and portrait orientations

[LEARN MORE](#)

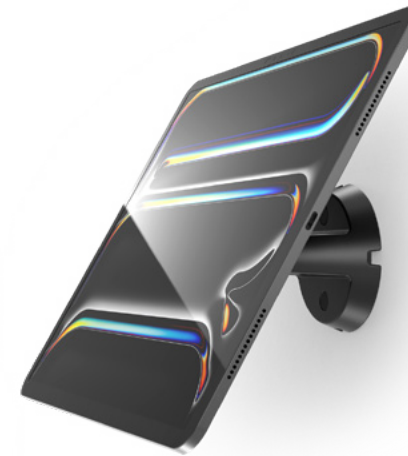

### Bow Tilting Wall Mount

**NEW!**

Compatible    **100x100mm VESA Mount**

- Tilt or pan screen
- Secures to any flat surface
- Four cable exit options
- Plate lock slot
- Easy hinge adjustment
- Portrait or landscape mountable
- Max screen size: 27"

[LEARN MORE](#)



### Cling Wall Mount

Compatible    **100x100mm VESA Mount**

- Universal, compatible with iPads / tablets 7" - 13", Max thickness: 9.3mm
- Rotates between portrait and landscape orientations
- Tamperproof design
- Secure cable management

[LEARN MORE](#)



### Space Enclosure Swing Wall Mount

**Best Seller**

**100x100mm VESA Mount**

- Conceals charging cable
- High-grade aluminum enclosure
- Quick lock and unlock keyed lock
- Tilt, pan, and swing for multiple display angles

[LEARN MORE](#)



## COUNTER STANDS

Engage your customers and promote your brand with secure iPad stands and kiosks. Display helpful information, product catalogs and promotions, or set up self-service kiosks for easy orders, check-ins, and more.

### Space Enclosure Core Stand



100x100mm VESA Mount    75x75mm VESA Mount

- Powder-coated steel stand
- Enclosure can be set in landscape or portrait orientation
- Wall or countertop mountable
- Add-on adhesive and Swivel bases

[LEARN MORE](#)

### Swell Enclosure Mast Stand



100x100mm VESA Mount    75x75mm VESA Mount

- Metal construction for extra durability
- Full reverse tilt
- Cable management
- Tilt tension screws
- Optional swivel base add-on (adhesive only)

[LEARN MORE](#)

### Glidetab Lock Stand



**NEW!** Compatible with Apple, Microsoft Surface, and Samsung Galaxy Tab

- Universal iPad stand
- Portrait or landscape orientation
- Keyed lock for easy removal
- 60° table top, 30° wall mounted viewing angle





# COUNTER STANDS

Made with high-quality materials, our iPad kiosk stands have a harmonious design, advanced security features, and are easy to install. They are adaptable to all types of environments. They ensure a perfect fit no matter the size, make, or model.



## Secured KickStand

- Metal kickstand for durability
- 6ft Keyed Cable lock included
- Dual angle - 7.5° and 30° stances
- Rubber feet for stability and traction
- Easy installation with 3M VHB pads

LEARN MORE



## Apex Rise Stand

100x100mm VESA Mount    75x75mm VESA Mount

- Height options available
- Through arm cable management
- Swiveling and tilting mount head
- Optional adhesive and freestanding bases

LEARN MORE

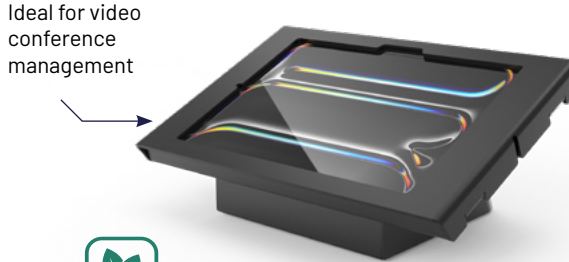

## Apex AV Capsule Stand

100x100mm VESA Mount     ECO



The mount is made from **98% recyclable aluminum**. Within this composition is **30% recycled aluminum**, ensuring a strong, sturdy design that provides reliable protection while also prioritizing environmentally friendly materials.

- Concealed storage space for cables and battery
- 30° table top, 60° wall mounted viewing angle
- Built-in cable lock slot

LEARN MORE



PORTABLE FLOOR STAND

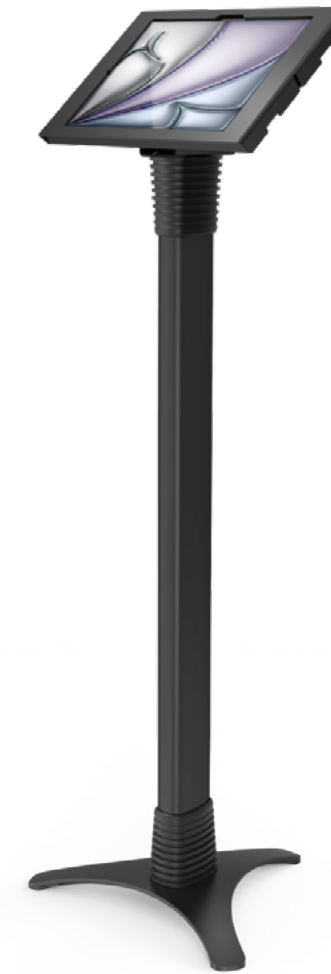

100x100mm  
VESA Mount

- Floor stand with adjustable height
- Fixed 45° viewing angle
- Cable management through the pole
- Space for charging block
- Set pole height 40"- 45"

LEARN MORE

BRANDABLE FLOOR STAND

NEW!



100x100mm  
VESA Mount

75x75mm  
VESA Mount

- Panel for branding, call to action, or custom design
- Internal lighting option for backlit branding
- Tilting mounting plate
- Cable management for charging while mounted
- Concealed storage space for adaptor, batteries, etc.

LEARN MORE



## ROLLING STANDS

Bring flexibility to your business and checkout process with this unique iPad solution. Securely dock any iPad to an elegant pole stand while being able to freely remove it and benefit from extra mobility and in-store efficiency. Dock and undock your iPad in a snap!

### IPad Rolling Cart

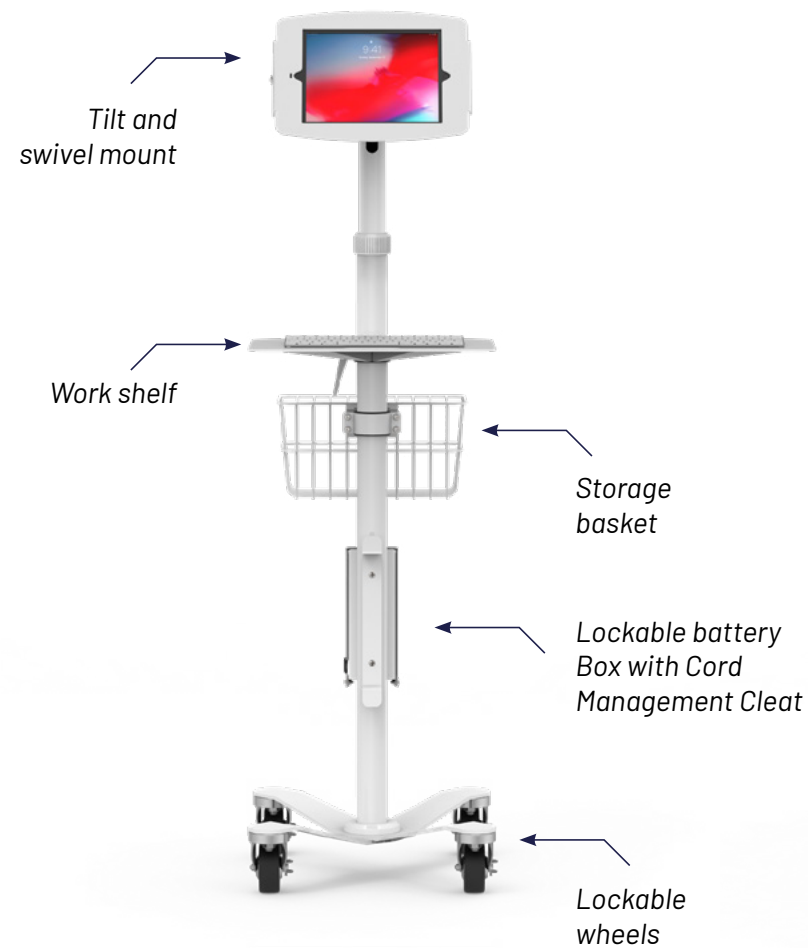

100x100mm VESA Mount    75x75mm VESA Mount

- Dynamic, rolling, hands-free workstation
- Through pole cable management
- Adjustable height and viewing angles
- Rolls easy and fits in tight spaces
- Perfect for healthcare and medical settings

[LEARN MORE](#)

### IPad Extended Rolling Cart



[LEARN MORE](#)

## OTHER MOUNTS

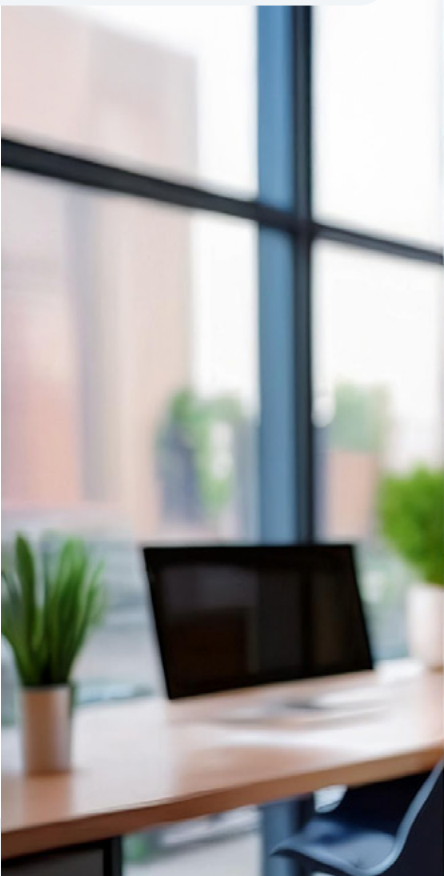

## OTHER MOUNTS

### Glass Mount

100x100mm  
VESA Mount

- Securely mount any iPad on smooth surfaces including marble and glass; no drilling required
- Easy to install and can be removed using a dedicated tool (supplied separately)
- Powerful VHB adhesive pads to fix to glass and other smooth surfaces

[LEARN MORE](#)

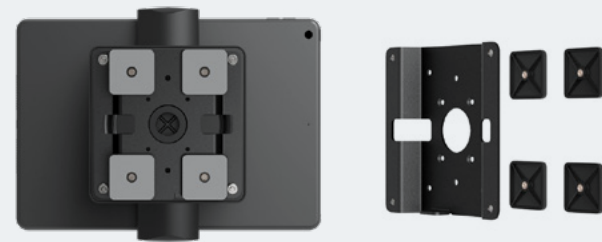

### Rail Mount

100x100mm  
VESA Mount

75x75mm  
VESA Mount

- Fix to rails 12.7mm (0.5") Ø to 38.0mm (1.50") Ø
- 360° screen swivel
- 125° screen flip

[LEARN MORE](#)





## APPLE MOUNTS



## APPLE MOUNTS



### Apple TV Security Mount

Best Seller



Compatible with all Apple TV models

- Easy fix to any flat surface
- Lightweight and low profile
- Ventilated aluminium construction
- Security slot for lockhead or cable lock

LEARN MORE

The mount is made from **98% recyclable aluminum**. Within this composition is **70% recycled aluminum**, ensuring a strong, sturdy design that provides reliable protection while also prioritizing environmentally friendly materials.



### Mac mini Security Mount

Best Seller



- Lightweight and low profile
- High-grade aluminum construction
- 100x100mm and 75x75mm VESA Mounting Pattern
- Security slot for lockhead or cable lock

LEARN MORE

Our new Mac mini Security Mount is **made from 98% recyclable aluminum**. Within this composition is **70% recycled aluminum**, ensuring a strong, sturdy design that provides reliable protection while also prioritizing environmentally friendly materials.

## MAC STUDIO LOCKS

### Mount ECO



The mount is made from **98% recyclable aluminum**. Within this composition is **70% recycled aluminum**, ensuring a strong, sturdy design that provides reliable protection while also prioritizing environmentally friendly materials.

- Secures directly to a flat surface or freestanding secured with cable lock
- Additional T-Bar lock slot for peripheral
- Ventilated design
- Unrestricted access to ports

LEARN MORE

## Ledge Lock



- Unique ledge lock adapter mechanism
- Creates accessible T-Bar lock slot compatible with standard cable locks
- Non-invasive
- Low profile solution

LEARN MORE

## Stand



- Mac Studio secured with cable lock to stand or fixed point
- Increases ventilation and decreases dust accumulation
- Allows use of standard T-Bar cable locks
- Maintains small footprint
- Additional T-Bar lock slot for peripheral

LEARN MORE

## OTHER MOUNTS



## LOCKS

Compatible with all MacBooks

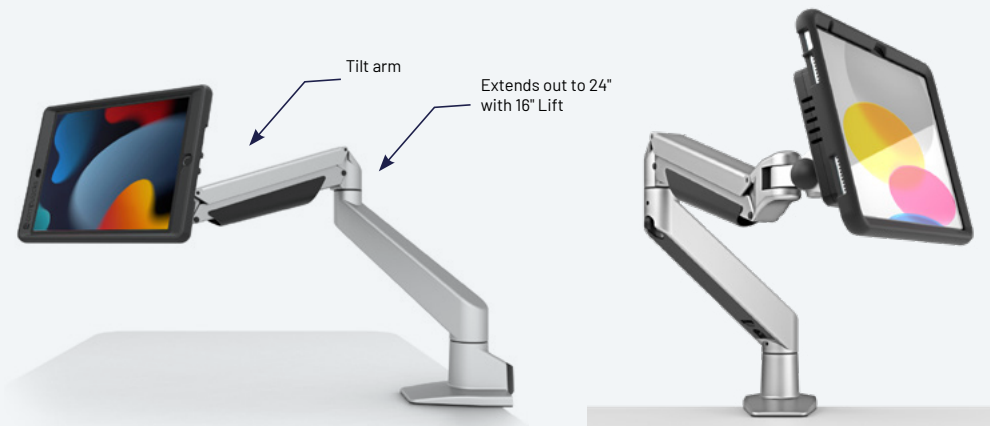

## Ergonomic Arm

- Wide range of motion: tilt, swing, and pan
- Clamp-on, mount through desk or wall mount
- Cable management keeps all wires and cords organized

100x100mm  
VESA Mount

75x75mm  
VESA Mount

LEARN MORE



## Macbook Ledge Lock

All Apple MacBook Pro & Air come with no means to secure them from theft. Compulocks produces an exclusive line of T-Slot adaptors called "Ledge" for each model of MacBook Pro and MacBook Air.

- Models compatible with all MacBook Pro and Air
- Compatible with standard T-Bar cable locks
- Cutting-edge design for maximum security
- Small size and weight

LEARN MORE

## DID YOU KNOW?

The FBI's National Crime Information Center estimates that each year up to 800,000 memory devices (MacBooks, iPads, etc.) are lost or stolen. Due to their value, securing Macbooks, laptops, and iPads is more urgent than ever.

\*Source: forbes.com

## LOCK ADAPTERS & CABLE LOCKS



### Universal Tablet Lock Best Seller

Compatible     

- Low-profile Universal Security Plate
- 3M VHB industrial adhesive
- 6ft galvanized steel cable lock
- Loop-ended cable for easy tethering

[LEARN MORE](#)



### Blade Universal Lock

Compatible     

- Universal for any device
- Extremely durable
- Compatible with standard T-bar cable lock
- Retractable "Blade" security slot

[LEARN MORE](#)



### Keyed Cable Lock

6ft T-Bar universal keyed cable lock

[LEARN MORE](#)



### Combination Cable Lock

6ft T-Bar universal combination cable lock

[LEARN MORE](#)



## POS TERMINAL SOLUTIONS

### EMV SlideDock Security Stand

- Universal device security stand
- Quick connect docking plate
- Optional rotation plate included
- Counter-top or wall mountable
- Simple, stylish, and secure
- Comes with vhb pad and swivel base

LEARN MORE



### Verifone T650m and CM5 Rugged Cases

- Nesting silicon and hard plastic cases for maximum shock and drop protection
- Easy grip surface
- Compatible with magnetic charging cable
- Full access to controls and ports

LEARN MORE



### Verifone T650m and CM5 Multichargers

- Simultaneously charge upto 5 devices
- Magnetic charging connection
- High-grade aluminum station
- Countertop or wall mountable
- For use with rugged cases

LEARN MORE



## Universal Hand Grip

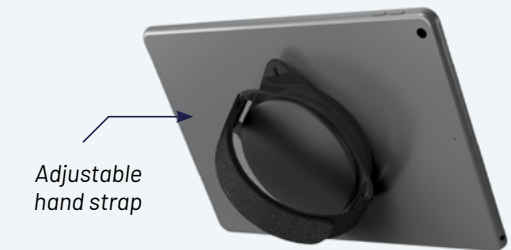

### Hand Grip

- Universal to fit all tablets and iPads
- Adjustable strap for a comfortable fit, even with gloves
- Industrial-strength adhesive
- 360 degree screen rotation

LEARN MORE



### Grip & Dock Station

- Secured 'grab and go' ipad/tablet stand
- Quick keyed lock and release system
- Wall or countertop mount

LEARN MORE



## PROTECTIVE SOLUTIONS



### Edge Case

**Rugged silicone protection**

- Rubberized for a firm grip and protection
- Cutouts for buttons, ports, and cameras
- Open back area for universal adhesive locking mechanisms

[LEARN MORE](#)



### Screen Shield

**Tempered glass screen protector**

- Shatterproof and scratch-resistant
- Maintains touchscreen sensitivity
- Crystal clear image resolution
- Nano-coating to repel finger marks and dust

[LEARN MORE](#)

# YOUR VISION, PERFECTED

At Compulocks, we offer customized tablet mounting solutions. Trust us to take your ideas and transform them into something extraordinary.

LEARN MORE



### Integration

Craft one-of-a-kind devices with modified enclosures for multiple gadgets.



### Branding

Personalize your solution with your logo and company colors.



### Sizing

Customize a unique size that isn't typically available in our lineup.



### Functionality

Enhance your enclosure with additional screws and custom slots.

Compulocks bespoke tablet printer kiosks bring **brand presence** to leading food service enterprise



## Get some design inspiration from other customers



Healthcare Translations

Learn More >>



On-the-Go POS

Learn More >>



NFC for Schools

Learn More >>

Featuring a universal 100X100 VESA to **mount any iPad**, and a retail-sized printer housing, the POS Printer Kiosk, perfectly caters to the bustling environment of restaurants and eateries.

This bespoke kiosk streamlines order processing and **enhances customer interaction**, embodying the efficiency that the company is renowned for. Crafted to complement the service's partnership with a myriad of restaurants, each kiosk is branded with their signature colors, making it a vibrant and visually appealing addition to any establishment while **maintaining brand presence**.

## Swell and Apex Enclosures

Apple iPad	Screen Size in Inch	Swell Enclosure
iPad (10th Gen)	10.9"	<a href="#">209SWLB</a>
		Apex Enclosure
iPad Air M2	11"	<a href="#">11APXB</a>
iPad Air M2	13"	<a href="#">13APXB</a>
iPad Pro M4	11"	<a href="#">11PAPX4B</a>
iPad Pro M4	13"	<a href="#">13PAPX4B</a>

## Space Enclosures

Apple iPad	Screen Size in Inch	Space Enclosure
iPad (10th Gen)	10.9"	<a href="#">209IPDSB</a>
iPad (7th-9th Gen)	10.2"	<a href="#">102IPDSB</a>
iPad Pro (3rd-6th Gen)	12.9"	<a href="#">299PSENB</a>
iPad Pro (1st-4th Gen)	11"	<a href="#">211SENB</a>
iPad Air (4th-5th Gen)	10.9"	<a href="#">109IPDSB</a>
iPad mini (6th-7th Gen)	8.3"	<a href="#">830IPMSB</a>

## Security KickStand

Apple iPad	Screen Size in Inches	Security KickStand
iPad (10th Gen)	10.9"	<a href="#">109KS01KL</a>
iPad (7th-9th Gen)	10.2"	<a href="#">102KS01KL</a>
iPad Mini (6th-7th Gen)	8.3"	<a href="#">830KS01KL</a>

## Apple Mounts

Apple TV				Security Mount
Apple TV 4K (3rd Gen)				<a href="#">ATVEN43</a>
Apple TV 4K (1st-2nd Gen)				<a href="#">ATVEN35</a>
Mac mini				
Mac mini M4				<a href="#">MMEN24</a>
Mac mini M1/M2				<a href="#">MMEN76</a>
Mac Studio	Lock adapter	Lock adapter with key lock	Bracket Mount	Desktop Stand
Mac Studio	<a href="#">MSLDG01</a>	<a href="#">MSLDG01CL</a>	<a href="#">MSBKT01</a>	<a href="#">MSSTD01</a>











## Apple Locks

Apple MacBook	Ledge Lock Adapter	Lock Adapter With Key Lock	Lock Adapter with Combination Lock	
MacBook Pro/Max 16-inch (M1/M2/M3/M4)	<a href="#">MBPR16LDG02</a>	<a href="#">MBPR16LDG02KL</a>	<a href="#">MBPR16LDG02CL</a>	
MacBook Pro/Max 14-inch (M1/M2/M3/M4)	<a href="#">MBPR14LDG01</a>	<a href="#">MBPR14LDG01KL</a>	<a href="#">MBPR14LDG01CL</a>	
MacBook Air 15-inch (M2/M3)	<a href="#">MBALDG05</a>	<a href="#">MBALDG05KL</a>	<a href="#">MBALDG05CL</a>	
MacBook Air 13-inch (M2)	<a href="#">MBALDG04</a>	<a href="#">MBALDG04KL</a>	<a href="#">MBALDG04CL</a>	
MacBook Air 13-inch (M1)	MBALDG03	MBALDG03KL	MBALDG03CL	
		Blade Bracket	Blade Bracket with keyed lock	Blade Bracket with Combination lock
All MacBooks		<a href="#">BLD01</a>	<a href="#">BLD01KL</a>	<a href="#">BLD01CL</a>











## Protective Accessories

Apple iPad	Screen Size in Inches	Screen Protector	Protective Edge Case
iPad Air M2	11"	<a href="#">DGIPDA11</a>	
iPad Air M2	13"	<a href="#">DGIPDA13</a>	
iPad Pro M4	11"	<a href="#">DGIPDP11</a>	
iPad Pro M4	13"	<a href="#">DGIPDP13</a>	
iPad (10th Gen)	10.9"	<a href="#">DGIPMN06</a>	<a href="#">BNDIP109</a>
iPad (7th-9th Gen)	10.2"		<a href="#">BNDIP102</a>
iPad mini (6th-7th Gen)	8.3"	<a href="#">DGIPMN06</a>	<a href="#">BNDIPMN6</a>









## Universal Solutions

										
Solution	Glidetab	Grip & Dock	Cling Stand	Universal iPad Lock	Secured EMV Stand	Universal iPad Holder	Solutions with Cling	Solutions with IT-mount	Solutions with Magnetix	iPad Rugged Cases
Part #	GLDTABB	<a href="#">189BGRPLCK</a>	<a href="#">UCLGSTDB</a>	<a href="#">CL15UTL</a>	<a href="#">199BSLDDCKB</a>	<a href="#">CL12UTHBB</a>	<a href="#">UCLGVWMB</a>	<a href="#">SMP01B</a>	<a href="#">VHBMM01</a>	<a href="#">820BRCH</a>

## Stands

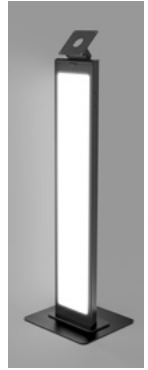
										
Solution	Mast Stand	Fixed 45° - Core Stand	Tilting 8" Counter Stand - Rise	Tilting 4" Counter Stand - Rise	AV Conference Room Capsule	iPad Printer Kiosk	Articulating Arm Mount - Reach	Flexible Counter Stand - Flex Arm	Tilting Wall Mount - Bow	Swing Wall Mount - Swing
Part #	<a href="#">333B</a>	<a href="#">111B</a>	<a href="#">TCDP01</a>	<a href="#">TCDP04</a>	<a href="#">341B</a>	<a href="#">PK01</a>	<a href="#">660REACH</a>	<a href="#">159B</a>	505B	<a href="#">827B</a>

## Stands

								
Solution	Brandable VESA Floor Stand for Screens Up to 32 Inches	Lighting Kit	Brandable Floor Stand - BrandMe	VESA Brandable Floor Stand with Lighting Kit UK Power Cord	VESA Brandable Floor Stand with Lighting Kit EU Power Cord	Portable Floor Stand - Adjustable	Rolling Cart Extended - Rise Freedom Extended	Rolling Cart - Rise Freedom
Part #	<a href="#">140BLBPB</a>	<a href="#">LK01-UK, LK01-EU</a>	<a href="#">140B</a>	<a href="#">140BLK01-UK</a>	<a href="#">140BLK01-EU</a>	<a href="#">147B</a>	<a href="#">MCRSTDEXW</a>	<a href="#">MCRSTDW</a>



# COMPULOCKS

DISPLAY. SECURE. ENGAGE

---

## Let's Meet!

Compulocks USA

[www.compulocks.com](http://www.compulocks.com)

[b2b@compulocks.com](mailto:b2b@compulocks.com)

## Scan to visit our websites

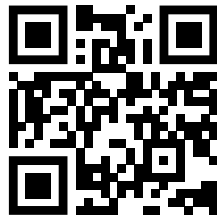

Visit Compulocks

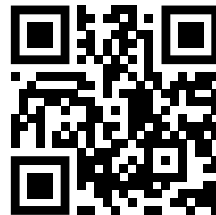

Visit Maclocks