

COMPULOCKS

# EVERYDAY CONNECTIONS, ENHANCED



## CATALOG 2024

DISPLAY. SECURE. ENGAGE

[compulocks.com](https://compulocks.com)

# ABOUT US

Compulocks is the leading design manufacturer of IT hardware security and tablet display solutions for businesses and across industries.

With an in-house R&D team and an understanding of every work environment's needs, we provide our clients with high end customer specific products that elevate their work, operations, and communications.

			<b>FORTUNE 500</b>
<b>Quality Assurance</b>	<b>Security Experts</b>	<b>International Service</b>	<b>Fortune 500</b>
Durable materials for long term usage	Creating security solutions for over 10 years	Operation in North America and Europe serving the world	Chosen by companies from start-up to Fortune 500



## I'M LOOKING FOR...

- 08 Recently Launched
- 14 Wall Displays
- 18 Counter Stands
- 24 Floor Stands
- 26 Rolling Stands
- 28 Other Mounts
- 30 Apple Mounts
- 31 Ergonomic Solutions
- 33 Locks
- 36 POS Terminal Solutions
- 38 Charge
- 40 Protective Solutions
- 42 Custom Solutions



**In 2024, our focus is  
on re-invention.**

With our design and engineering experience we are committed to **improving the way people work.**

We are launching new products that enhance connectivity and enable the advances in technology to benefit every workplace.

# HOW DO YOU WANT TO MOUNT YOUR TABLET?

All of Compulocks' tablet holders can be paired with any of our floor, wall, or counter displays to fit every tablet and use case. Compulocks allows you to create your best combination. Here are a few examples:

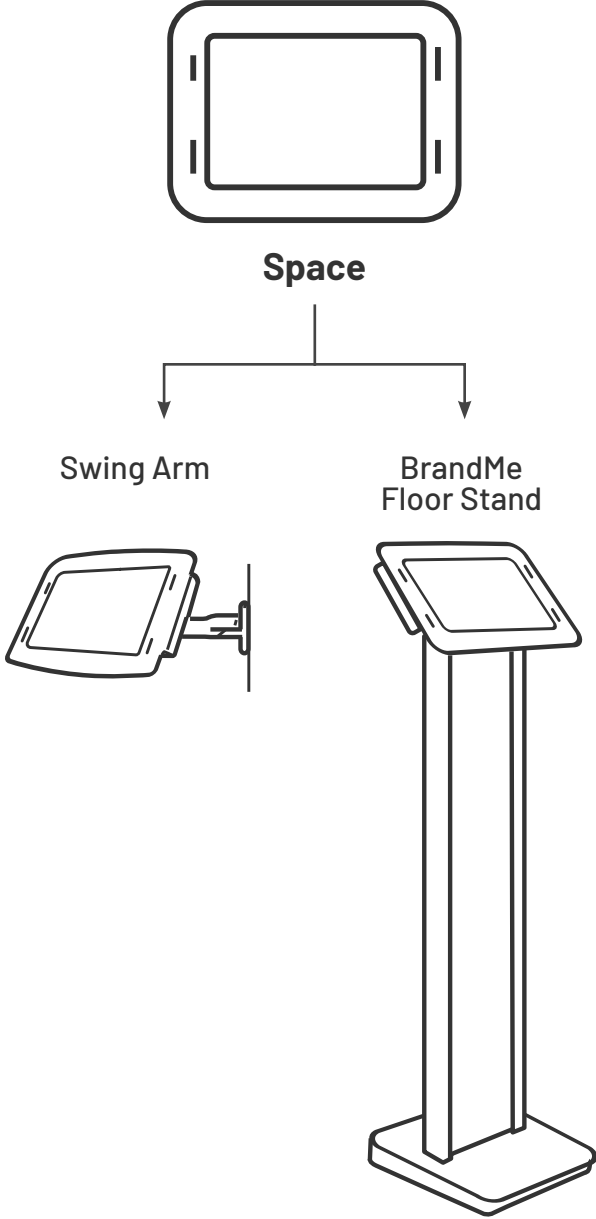

Enclosed  
Secured with key  
Stylish design

[LEARN MORE](#)

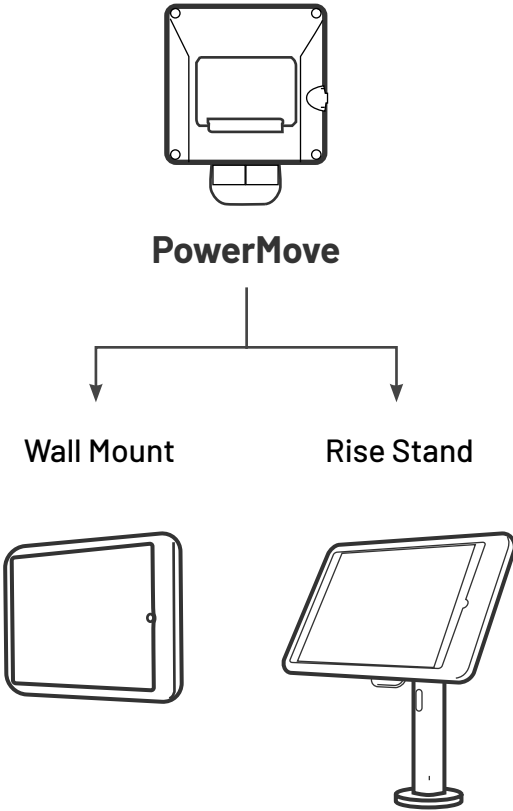

Charging display  
Click on/off  
Allows mobility

[LEARN MORE](#)

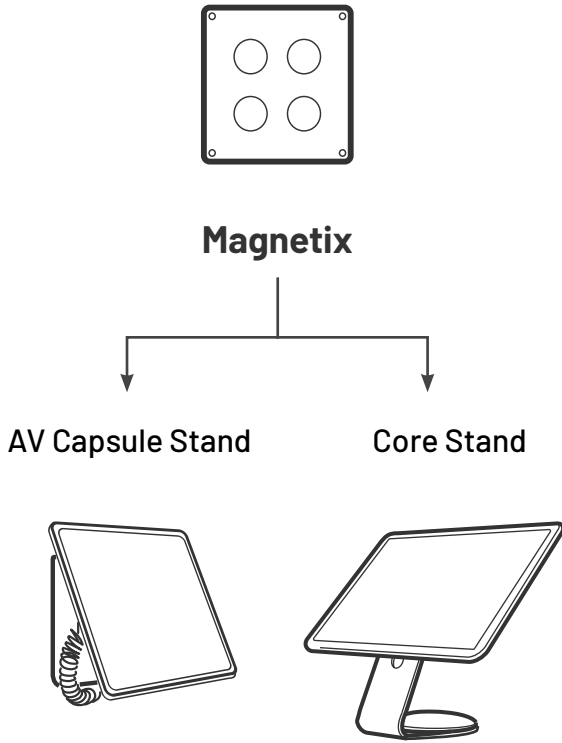

Universal  
Allows mobility  
Click on/off

[LEARN MORE](#)

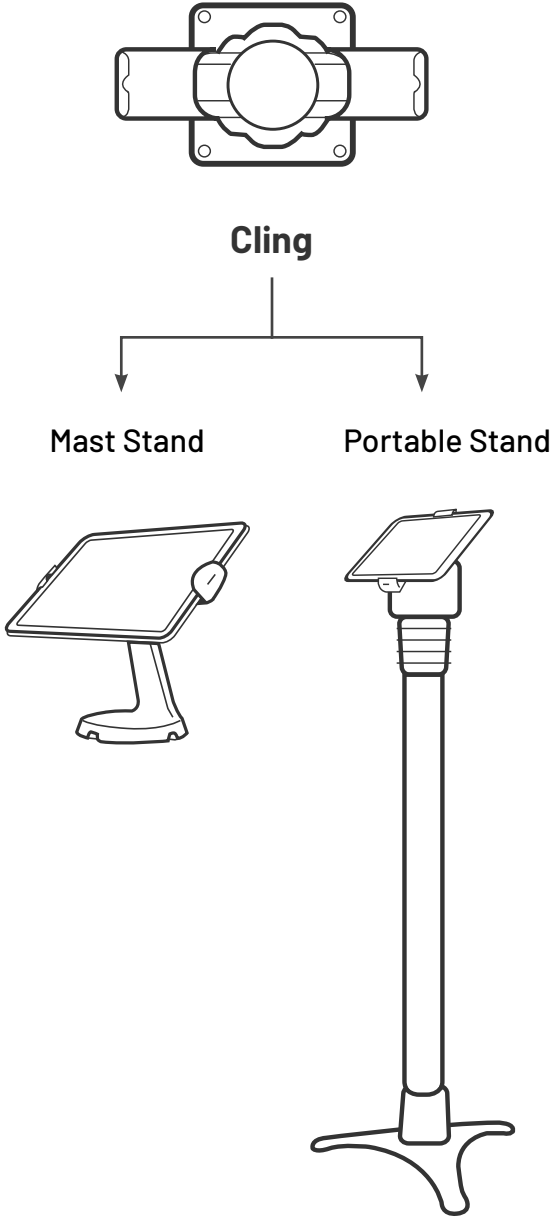

Universal  
Portrait/Landscape orientation  
Intuitive design

[LEARN MORE](#)





## POWERMOVE NEW!

PowerMove is an all-in-one solution - ensuring constant charging and data transfer on stand, with an intuitive Lift-to-Release mechanism for full mobility around the workplace. For all USB-C iPads and tablets, PowerMove is compatible across Compulocks' counter, wall and floor stands.

### STREAMLINE YOUR OPERATIONS

PowerMove is the ideal **solution** across industries and use needs - whether you are in **custom service, warehousing, quality control or conducting sales** on the go.

[LEARN MORE](#)

## MOBILITY. CONNECTIVITY. SECURITY.

The keyed locking **mechanism** ensures 100% peace of mind, keeping your iPad **secure in any environment**. Plus, with convenient pogo pins for charging and data, your iPad will always be powered up and ready for action.



## THE POWERMOVE FEATURES

100x100mm  
VESA Mount

- Pogo pins for connectivity and charging
- Allows data and power transfer through USB-C interface
- Locking mechanism for tablet security
- Direct charging port when detached from dock
- Edge Case to conceal wiring and protect connections and tablet
- Easy to use "lift to release" mechanism
- Integrated kickstand on tablet side

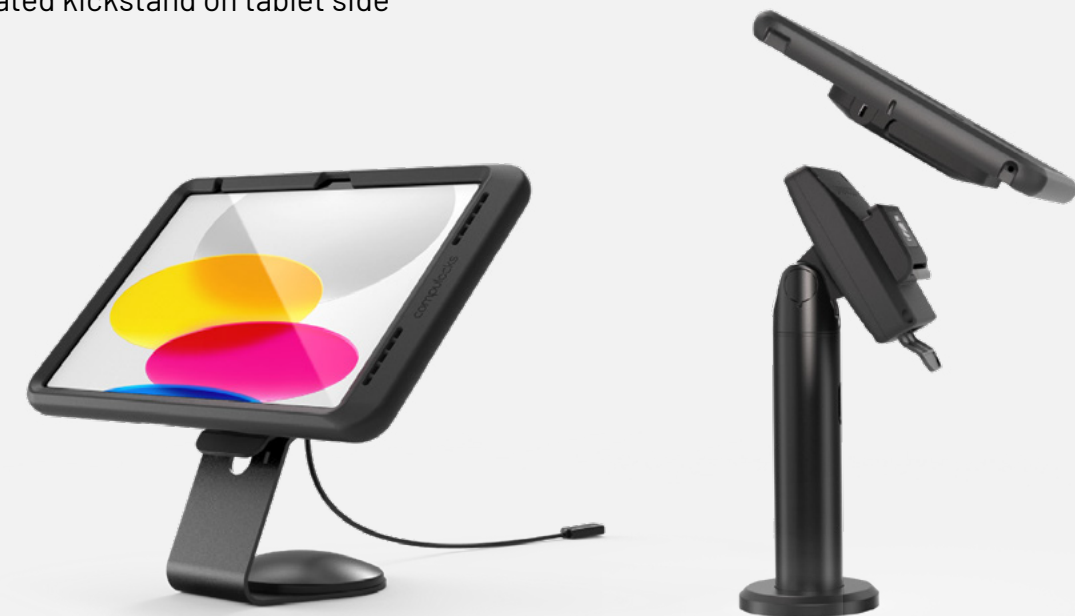

# EXPAND YOUR TABLET CONNECTIVITY!



## CONNECTIVITY RE-IMAGINED

Connect your tablet to a **large screen** for immersive presentations, link it to a **printer or scanner** for seamless document management, or effortlessly connect a **keyboard** for enhanced productivity. **The Plus Hub makes it all simpler and more efficient.**



## THE PLUS HUB FEATURES

100x100mm  
VESA Mount

- Hub ports specification : USBPD, USB-C, HDMI, 2xUSB-A, RJ45
- Allows data and power transfer through USB-C interface
- Ventilation holes incorporated to ensure proper temperature regulation
- Option for direct wall mounting

## COMPATIBILITY



Compatible with all products with a USB-C port



## PLUS HUB NEW!

The Plus Hub is a multi-functional media add-on that transforms your tablet use. Combined with our range of counter, wall or floor stands, the Plus Hub is a streamlined and aesthetic solution to organize connectivity.

Group your wires and ports to create a **clean and organised setup** that enhances your workspace.

LEARN MORE







## SECURED KICKSTAND NEW!

Robust yet **lightweight**, the Secured KickStand allows you to **handle, work with and display** your tablet whilst enjoying unmatched **mobility**. The rugged rubber Edge Case provides extra protection as all bundles come with a locking solution to ensure 100% device security.

[LEARN MORE](#)

## UNLIMITED FUNCTIONALITY

Fitting **trade shows**, in a **retail** environment, or **healthcare** setting, The Secured KickStand provides the perfect solution for every use case.



## SECURED KICKSTAND FEATURES

- Metal kickstand for durability
- 6ft Keyed Cable Lock included
- Dual angle - 7.5° and 30° stances
- Rubber feet for stability and traction
- Easy installation with 3M VHB pads



## COMPATIBILITY

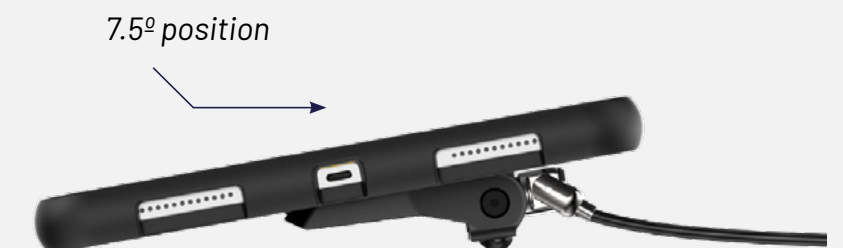





## Wall Displays

Compulocks' wall displays are compatible with every iPad and tablet made by leading brands.

### Apex **Top Security**

100x100mm VESA Mount | 75x75mm VESA Mount

Compatible   

- Sleek metal frame
- Quick keyed access
- Option for direct wall mounting
- Exposed front and back cameras and sensors



Portrait Or  
Landscape  
Orientation

### Swell **Stylish & Intuitive**

100x100mm VESA Mount | 75x75mm VESA Mount | Compatible 

- Metal construction for extra durability
- Closed and minimal design for maximum protection of the tablet
- Tamperproof screws
- Exposed front and back cameras including sensors
- Direct access to the iPad USB-C port



Portrait Or  
Landscape  
Orientation

[LEARN MORE](#)

### Space **Classic & Reliable**

100x100mm VESA Mount | Compatible   

- High-grade aluminum enclosure with rounded edges
- Quick keyed access
- Conceals charging cable
- Designed to expose cameras and sensors



Portrait Or  
Landscape  
Orientation

[LEARN MORE](#)





## Wall Displays

Create a comfortable and functional space to display important information with wall mounts and enclosures from Compulock's. These universal tablet wall mounts with locks are easy to install on any VESA-compatible stand and come with a cable management system for a clean look while charging

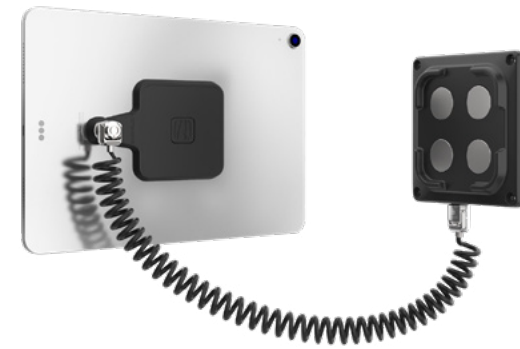

### Magnetix Wall Mount

Compatible 100x100mm VESA Mount

- Universal mount system for all iPads / tablets
- For displays and handheld use, cable lock secured
- Easily switch between landscape and portrait orientations

[LEARN MORE](#)



### Invisible Swing Wall Mount

Compatible 100x100mm VESA Mount

- Universal, compatible with any iPad / tablet laptop with min. 8" x 5" flat fixing area
- Tilt, pan, and swing for multiple display angles
- Industrial strength adhesive

[LEARN MORE](#)



### Cling Wall Mount

Compatible 100x100mm VESA Mount

- Universal, compatible with iPads / tablets 7" - 13", Max thickness: 9.3mm
- Rotates between portrait and landscape orientations
- Tamperproof design
- Secure cable management

[LEARN MORE](#)



### Space Enclosure Swing Wall Mount

**Best Seller**

- Conceals charging cable
- High-grade aluminum enclosure
- Quick lock and unlock keyed lock
- Tilt, pan, and swing for multiple display angles

[LEARN MORE](#)



## Counter Stands

Engage your customers and promote your brand with secure tablet stands and kiosks. Display helpful information, product catalogs and promotions, or set up self-service kiosks for easy orders, check-ins, and more



## Space Enclosure Core Stand

NEW!

100x100mm  
VESA Mount

75x75mm  
VESA Mount

- Powder coated steel stand
- Enclosure can be set in landscape or portrait orientation
- Wall or countertop mountable
- Add-on adhesive and Swivel bases

LEARN MORE



## Swell Enclosure Mast Stand

NEW!

100x100mm  
VESA Mount

75x75mm  
VESA Mount

- Metal construction for extra durability
- Full reverse tilt
- Cable management
- Tilt tension screws
- Optional swivel base add-on (adhesive only)



## HoverTab Lock Stand

Best Seller

Compatible

Apple Microsoft Surface Samsung Galaxy Tab

- Universal tablet and iPad stand
- Portrait or landscape orientation
- Keyed lock for easy removal
- 60° table top, 30° wall mounted viewing angle

LEARN MORE





## Counter Stands

Made with high-quality materials, our tablet kiosk stands have a harmonious design, advanced security features, and are easy to install. They are adaptable to all types of environments. They ensure a perfect fit no matter the size, make, or model.

## Secured KickStand

NEW!



- Metal kickstand for durability
- 6ft Keyed Cable lock included
- Dual angle - 7.5° and 30° stances
- Rubber feet for stability and traction
- Easy installation with 3M VHB pads

LEARN MORE

Screen tilt & swivel

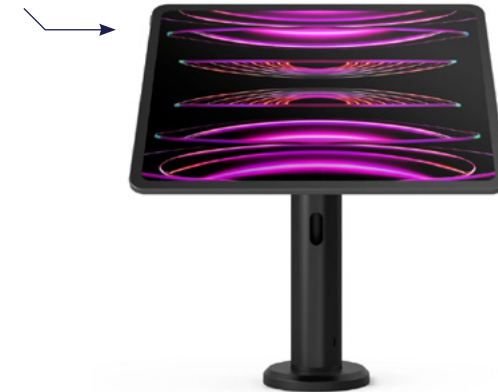

## Invisible Mount Rise Stand

100x100mm  
VESA Mount

75x75mm  
VESA Mount

- Height options available
- Through arm cable management
- Swiveling and tilting mount head
- Optional adhesive and free-standing bases

LEARN MORE

Ideal for video  
conference  
management



## Magnetix AV Capsule Stand

100x100mm  
VESA Mount

- Universal tablet and iPad stand
- Concealed storage space for cables and battery
- 30° table top, 60° wall mounted viewing angle
- Built-in cable lock slot

LEARN MORE





Choice of Enclosure or Universal Tablet Mount

Dedicated POS printer space

## FIT FOR ANY BUSINESS

Equipped with a universal 100X100 VESA mount, the POS Printer Kiosk is compatible with a wide range of Compulock's tablets enclosures and mounts, ensuring seamless integration with your existing devices.

The kiosk's standard size accommodates most printers used in the retail and hospitality industries, offering unparalleled convenience and functionality.

## TABLET PRINTER KIOSK FEATURES

- 100X100 VESA compatibility
- Securely mount a variety of tablets and iPads
- Sturdy, high-quality iPad/tablet holder
- Printer dimensions - H- 160 mm / 6.3 in, W- 130 mm / 5.12 in, D- 150 mm / 5.91 in
- Secures onto the counter

## COMPATIBILITY



## TABLET PRINTER KIOSK

The Tablet Printer Kiosk is a tablet holder, featuring a secure housing for a retail-sized printer, making it an indispensable asset for any fast-paced retail, hospitality, or business environment.





## Floor Stands

Brandable Floor Stand **NEW!**



100x100mm  
VESA Mount

- Panel for branding, call to action, or custom design
- Internal lighting option for backlit branding
- Tilting mounting plate
- Cable management for charging while mounted
- Concealed storage space for adaptor, batteries, etc.

[LEARN MORE](#)

Portable Floor Stand

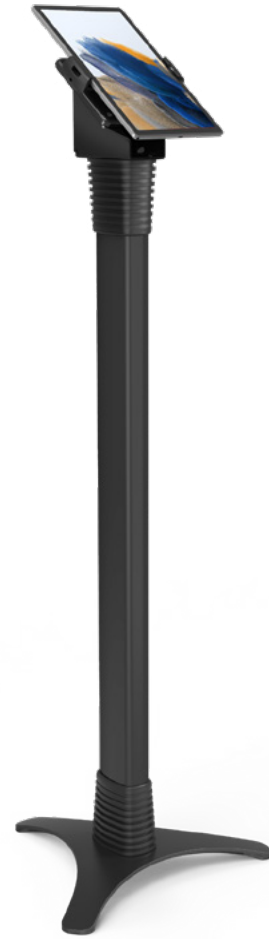

100x100mm  
VESA Mount

- Floor stand with adjustable height
- Fixed 45° viewing angle
- Cable management through the pole
- Space for charging block
- Set pole height 40"- 45"

[LEARN MORE](#)







## Rolling Stands

### Tablet Rolling Cart

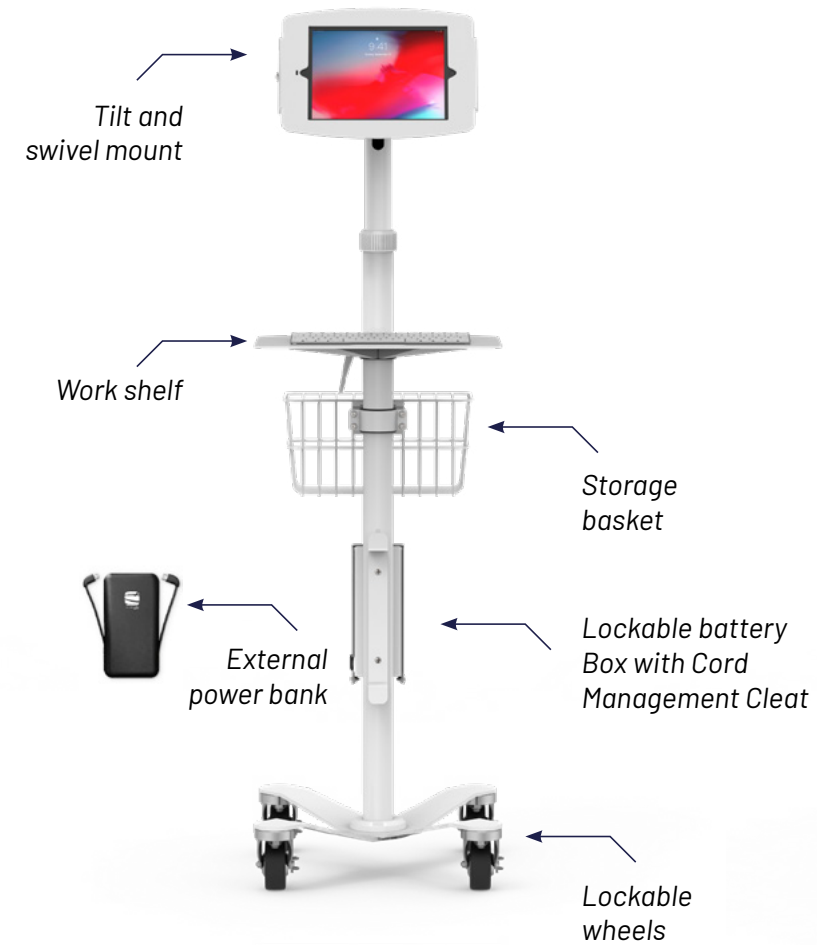

100x100mm VESA Mount    75x75mm VESA Mount

- Dynamic, rolling, hands-free workstation
- Through pole cable management
- Adjustable height and viewing angles
- Rolls easy and fits in tight spaces
- Perfect for healthcare and medical settings

[SEE MORE](#)

[LEARN MORE](#)

### Tablet Extended Rolling Cart



[LEARN MORE](#)





## Other Mounts

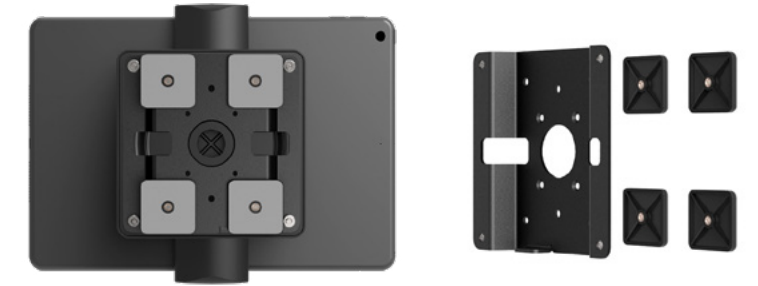

## Glass Mount

100x100mm  
VESA Mount

- Securely mount any iPad or tablet on smooth surfaces including marble and glass; no drilling required
- Easy to install and can be removed using a dedicated tool (supplied separately)
- Powerful VHB adhesive pads to fix to glass and other smooth surfaces

LEARN MORE



## Rail Mount

100x100mm  
VESA Mount

75x75mm  
VESA Mount

- Fix to rails 12.7mm (0.5") Ø to 38.0mm (1.50") Ø
- 360° screen swivel
- 125° screen flip

LEARN MORE



## Apple Mounts



### Apple TV Security Mount

Best Seller

Compatible with all Apple TV models

- Easy fix to any flat surface
- Lightweight and low profile
- Ventilated aluminium construction
- Security slot for lockhead or cable lock

LEARN MORE



### Mac mini Security Mount

Best Seller

- Lightweight and low profile
- High-grade aluminum construction
- 100x100mm and 75x75mm VESA Mounting Pattern
- Security slot for lockhead or cable lock

LEARN MORE

## Mac Studio Locks

### Mount



- Secures directly to a flat surface or freestanding secured with cable lock
- Additional T-Bar lock slot for peripheral
- Ventilated design
- Unrestricted access to ports

LEARN MORE

### Ledge Lock



- Unique ledge lock adapter mechanism
- Creates accessible T-Bar lock slot compatible with standard cable locks
- Non invasive
- Discrete low profile solution

LEARN MORE

### Stand



- Mac Studio secured with cable lock to stand or fixed point
- Increases ventilation and decreases dust accumulation
- Allows use of standard T-Bar cable locks
- Maintains small footprint
- Additional T-Bar lock slot for peripheral

LEARN MORE





## Ergonomic Arm

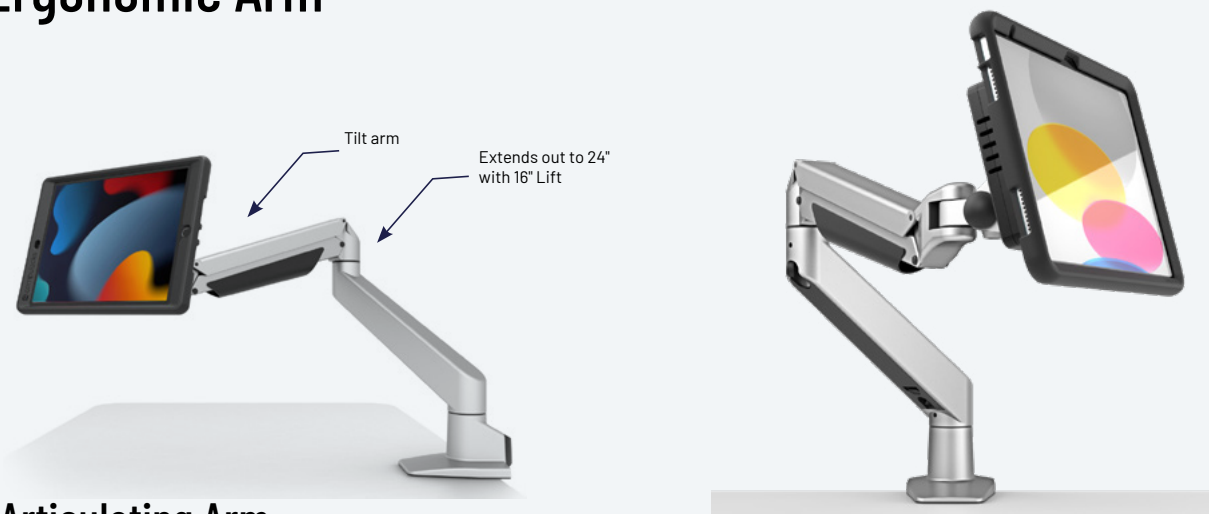

### Articulating Arm

- Wide range of motion: tilt, swing, and pan
- Clamp-on, mount through desk or wall mount
- Cable management keeps all wires and cords organized

100x100mm  
VESA Mount

75x75mm  
VESA Mount

LEARN MORE



## Macbook Ledge Lock

Compatible with all MacBooks



All Apple MacBook Pro & Air come with no means to secure them from theft. Compulocks produces an exclusive line of T-Slot adaptors called "Ledge" for each model of MacBook Pro and MacBook Air.

- Models compatible with all MacBook Pro and Air
- Compatible with standard T-Bar cable locks
- Cutting edge design for maximum security
- Small size and weight

LEARN MORE



# DID YOU KNOW?

The FBI's National Crime Information Center estimates that each year up to 800,000 memory devices (laptops, tablets etc) are lost or stolen. Due to their value, securing Macbooks, Laptops and iPads is more urgent than ever.

\*Source: forbes.com

## Locks

### Lock Adapters & Cable Locks



#### Universal Tablet Lock

Best Seller





Compatible     

- Low-profile Universal Security Plate
- 3M VHB industrial adhesive
- 6ft galvanized steel cable lock
- Loop ended cable for easy tethering

[LEARN MORE](#)



#### Blade Universal Lock

Compatible     

- Universal for any device
- Extremely durable
- Compatible with standard T-bar cable lock
- Retractable "Blade" security slot

[LEARN MORE](#)



#### Surface Ledge Lock Adapter

Compatible 

- Patented design for Surface Pro & Go devices
- Easy lock and release mechanism
- Fits perfectly on the kickstand
- Compatible with standard T-bar cable lock

[LEARN MORE](#)



#### Keyed Cable Lock

6ft T-Bar universal keyed cable lock

[LEARN MORE](#)



#### Combination Cable Lock

6ft T-Bar universal combination cable lock

[LEARN MORE](#)

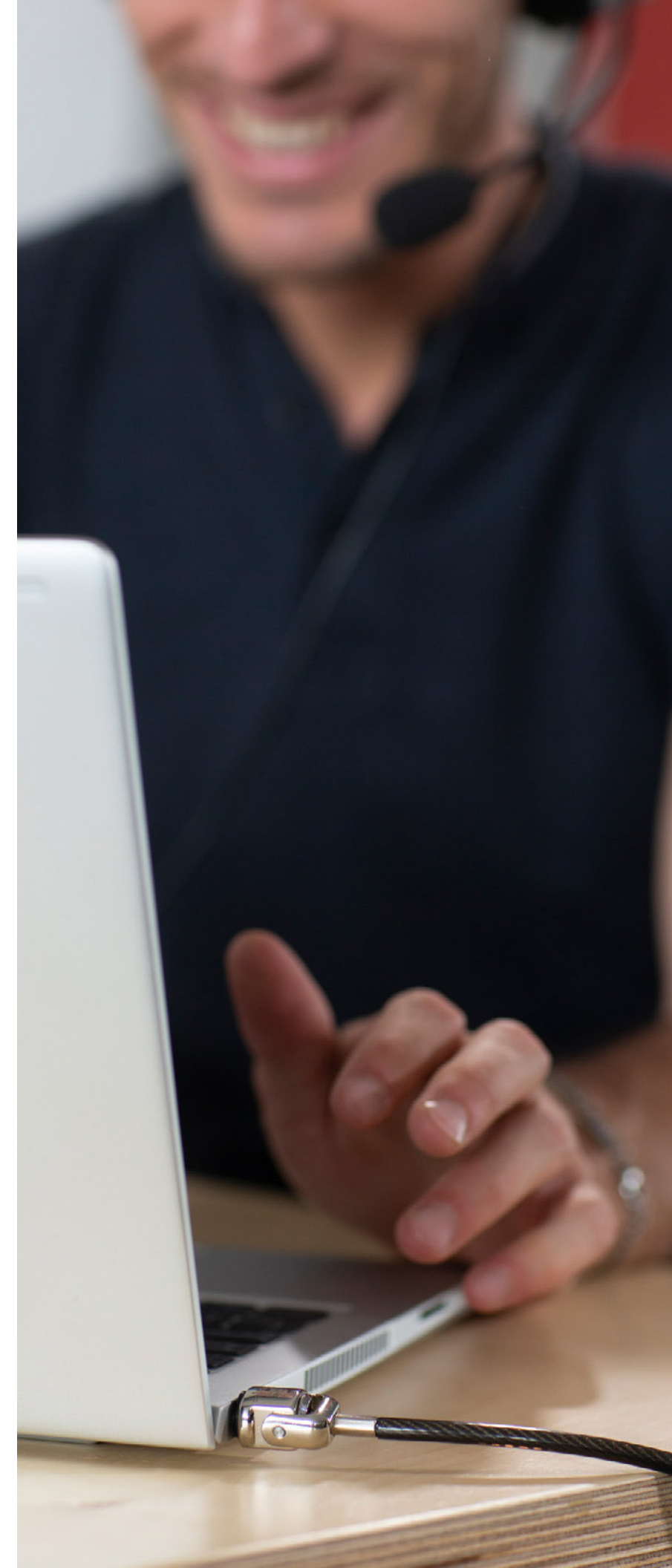





## Pos Terminal Solutions

### EMV SlideDock Security Stand

- Universal device security stand
- Quick connect docking plate
- Optional included rotation plate
- Counter-top or wall mountable
- Simple, stylish, and secure
- Comes with vhb pad and swivel base

[LEARN MORE](#)



### Verifone T650m and CM5 Rugged Cases

- Nesting silicon and hard plastic cases for maximum shock and drop protection
- Easy grip surface
- Compatible with magnetic charging cable
- Full access to controls and ports

[LEARN MORE](#)



### Verifone T650m and CM5 Multichargers

- Simultaneously charge upto 5 devices
- Magnetic charging connection
- High-grade aluminum station
- Countertop or wall mountable
- For use with rugged cases

[LEARN MORE](#)

## Universal Hand Grip

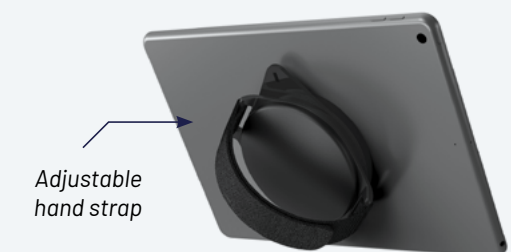

Adjustable hand strap

### Hand Grip

- Universal to fit all tablets and iPads
- Adjustable strap for a comfortable fit, even with gloves
- Industrial-strength adhesive
- 360 degree screen rotation

[LEARN MORE](#)



360° screen rotation

Tilt and swivel movement

### Grip & Dock Station

- Secured 'grab and go' ipad/tablet stand
- Quick keyed lock and release system
- Wall or countertop mount

[LEARN MORE](#)

## SECURED POWERSTRIP NEW!

Introducing Compulocks' new and innovative solution to secure and protect Apple Power Adapters and cables.



## PROTECTION & EASE

Designed to end the **inconvenient and expensive** replacement of cables and Power Adapters through theft and loss, the Secured PowerStrip has 6 sockets for **multiple Apple devices**, in a protective case with access to on/off switch. It creates an anti-theft **multi-port USB-C charging system**, with the charge cubes provided with your devices

[LEARN MORE](#)

## FUNCTIONAL INSTALLATION

PowerStrip is **easily mounted** on countertop and wall locations, providing the **ultimate** protection and deterrence.



## THE SECURED POWERSTRIP FEATURES

- 6 Socket powerstrip
- Cable protection and strain relief
- High-grade aluminum casing
- Can secure 2 ac power cables (up to 0.39" / 10 Mm ø)
- Power strip on/off
- Reset switch accessible while secured
- Security lock slot

## COMPATIBILITY

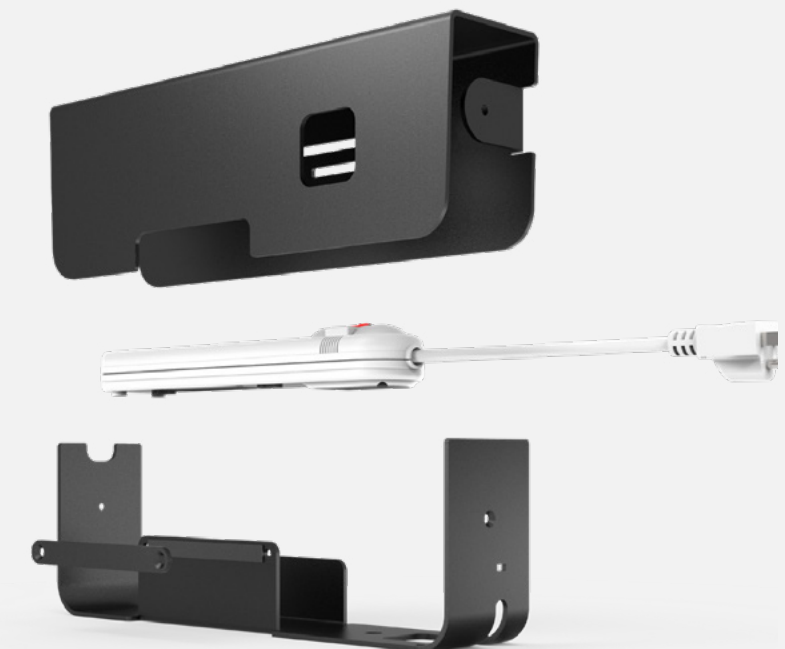
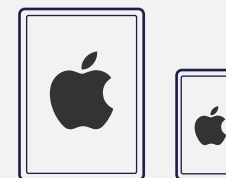





## Protective Solutions



### Edge Case

#### Rugged silicon protection

- Rubberized for a firm grip and protection
- Cutouts for buttons, ports, and cameras
- Open back area for universal adhesive locking mechanisms

[LEARN MORE](#)



### Screen Shield

#### Tempered glass screen protector

- Shatter-proof and scratch-resistant
- Maintains touchscreen sensitivity
- Crystal clear image resolution
- Nano-coating to repel finger marks and dust

[LEARN MORE](#)



# CUSTOM MADE SOLUTIONS

Work culture is changing all the time and **every work environment** has different and specific needs. With a track record of delivering transformative, functional experiences across the world, **we are dedicated to advancing** brands' messages and visions by creating the right solution for any organization.

LEARN MORE



## 2023 Custom Case Study

### Compulocks' bespoke tablet printer kiosk brings brand presence to leading food service enterprise

Featuring a universal 100X100 VESA to **mount any tablet or iPad**, and a retail sized printer housing, the POS printer Kiosk, perfectly caters to the bustling environment of restaurants and eateries.

This bespoke kiosk streamlines order processing and **enhances customer interaction**, embodying the efficiency that the company is renowned for.

Crafted to complement the service's partnership with a myriad of restaurants, each kiosk is branded with their signature colors, making it a vibrant and visually appealing addition to any establishment, while maintaining brand presence.



## Space Enclosures

Apple iPad	Screen Size in Inch	Release year	Space Enclosure
iPad (10th Gen)	10.9"	2022	209IPDSB
iPad (9th Gen)	10.2"	2021	102IPDSB
iPad (8th Gen)	10.2"	2020	102IPDSB
iPad (7th Gen)	10.2"	2019	102IPDSB
iPad Pro (6th Gen)	12.9"	2022	299PSENB
iPad Pro (5th Gen)	12.9"	2021	299PSENB
iPad Pro (4th Gen)	12.9"	2020	299PSENB
iPad Pro (3rd Gen)	12.9"	2018	299PSENB
iPad Pro (4th Gen)	11"	2022	211SENB
iPad Pro (3rd Gen)	11"	2021	211SENB
iPad Pro (2nd Gen)	11"	2020	211SENB
iPad Pro (1st Gen)	11"	2018	211SENB
iPad Air (4th & 5th Gen)	10.9"	2020 - 2022	109IPDSB
iPad Mini (6th Gen)	8.3"	2021	830IPMSB
<b>Samsung Galaxy Tab</b>			
Samsung Galaxy Tab A8	10.5"	2022	105GA85B
Samsung Galaxy Tab A7 Lite	8.7"	2021	870GA7SB
Samsung Galaxy Tab A7	10.4"	2020	104GA7SB
Samsung Galaxy Tab A	8"	2020	2084GASB
Samsung Galaxy Tab A	10.1"	2019	1910GASB
<b>Microsoft Surface</b>			
Surface Pro 9	13"	2022	580SPSB
Surface Pro 8	13"	2021	580SPSB
Surface Pro 3-7 & Pro 7+	12.3"	2020	540GEB
Surface Go 3	10.5"	2021	510GOSB

## Swell And Apex Enclosures

Apple iPad	Screen Size in Inch	Release year	Swell Enclosure
iPad (10th Gen)	10.9"	2022	209SWLB
<b>Samsung Galaxy Tab</b>			
Screen Size in Inch	Release year	Apex Enclosure	
Galaxy Tab A9	8.7"	2023	87GAPX9B
Galaxy Tab A9+	11"	2023	11GAPX9B
Galaxy Tab S9FE	10.9"	2023	109GFAPXB
Galaxy Tab S9FE+	12.4"	2023	124GFAPXB
Galaxy Tab S8/S9 Ultra	14.6"	2023	146GUAPXB
<b>Microsoft Surface</b>			
Surface Go (1-4)	10.5"	2023	510APXB
Surface Pro (8-9)	13"	2022	580APXB

## Stands



Solution	Mast Stand	Fixed 45° Core Counter Stand	Tilting 8" Counter Stand - "Rise"	Tilting 4" Counter Stand - "Rise"	AV Conference Room Capsule	Flexible Counter Stand - "Flex Arm"	Brandable Floor Stand - "BrandMe"	Portable Floor Stand - "Adjustable"	Rolling Cart Extended - "Rise Freedom Extended"	Rolling Cart - "Rise Freedom"	Articulating Arm Mount - "Reach"	Swing Wall Mount - "Swing"
Part #	303B	111B	TCDP01	TCDP04	341B	159B	140B	147B	MCRSTDEXW	MCRSTDW	660REACH	827B

## Universal solutions



Solution	Hovertab	Grip & Dock	Cling Stand	Universal Tablet Lock	Secured EMV Stand	Universal Tablet Holder	Solutions with Cling	Solutions with IT-mount	Solutions with Magnetix	Tablet Rugged Cases
Part #	HOVERTAB	189BGRPLCK	UCLGSTDB	CL15UTL	199BSLDDCKB	CL12UTHBB	UCLGVWMB	SMP01B	VHBMM01	820BRCH



## Apple Locks

Apple MacBook	Ledge Lock Adapter	Lock Adapter With Key Lock	Lock Adapter With Combination Lock
MacBook (16-inch, M3 Pro/Max, 2023)	MBPR16LDG02	MBPR16LDG02KL	MBPR16LDG02CL
MacBook (14-inch, M3 Pro/Max, 2023)	MBPR14LDG01	MBPR14LDG01KL	MBPR14LDG01CL
MacBook (16-inch, M2 Pro/Max, 2023)	MBPR16LDG02	MBPR16LDG02KL	MBPR16LDG02CL
MacBook (14-inch, M2 Pro/Max, 2023)	MBPR14LDG01	MBPR14LDG01KL	MBPR14LDG01CL
MacBook (16-inch, M1 Pro/Max, 2021)	MBPR16LDG02	MBPR16LDG02KL	MBPR16LDG02CL
MacBook (14-inch, M1 Pro/Max, 2021)	MBPR14LDG01	MBPR14LDG01KL	MBPR14LDG01CL
MacBook Air (15-inch, M2 2023)	MBALDG05	MBALDG05KL	MBALDG05CL
MacBook Air (13-inch, M2 2022)	MBALDG04	MBALDG04KL	MBALDG04CL
MacBook Air (13-inch, M1, 2020)	MBALDG03	MBALDG03KL	MBALDG03CL
MacBook Air (13-inch, 2020)	MBALDG03	MBALDG03KL	MBALDG03CL
MacBook (13-inch, M2 2022)	UNVMBPRLDG01	UNVMBPRLDG01KL	
MacBook (13-inch, M1, 2020)	UNVMBPRLDG01	UNVMBPRLDG01KL	
	<b>Blade Bracket</b>	<b>Blade Bracket with keyed lock</b>	<b>Blade Bracket with Combination lock</b>
All MacBooks	BLD01	BLD01KL	BLD01CL

## Security KickStand

Apple iPad	Screen Size in Inch	Security KickStand
iPad (10th Gen)	10.9"	109KS01KL
iPad (9th Gen)	10.2"	102KS01KL
iPad Mini (6th Gen)	8.3"	830KS01KL
Samsung Galaxy Tab A8	10.5"	105KS01KL

## Apple Mounts

Apple TV	Security Mount			
Apple TV 4K (3rd Generation) 2022	ATVEN43			
Apple TV 4K (2nd Generation) 2021	ATVEN35			
Apple TV 4K (1st Generation) 2017	ATVEN35			
<b>Mac mini</b>				
Mac mini M2 2023	MMEN76			
Mac mini M1 2020	MMEN76			
Mac mini 2018	MMEN76			
Mac Studio	Lock adapter	Lock adapter with key lock	Bracket Mount	Desktop Stand
Mac Studio	MSLDG01	MSLDG01CL	MSBKT01	MSSTD01

## Protective Accessories

Apple iPad	Screen Size in Inch	Screen Protector	Protective Edge Case
iPad (10th Gen)	10.9"	DGIPD109	BNDIP109
iPad (9th Gen)	10.2"	DGIPD102	BNDIP102
iPad (8th Gen)	10.2"	DGIPD102	BNDIP102
iPad (7th Gen)	10.2"	DGIPD102	BNDIP102
iPad Pro (6th Gen)	12.9"	DGSIPDP129	
iPad Pro (5th Gen)	12.9"	DGSIPDP129	
iPad Pro (4th Gen)	12.9"	DGSIPDP129	
iPad Pro (3rd Gen)	12.9"	DGSIPDP129	
iPad Pro (4rd Gen)	11"	DGSIPDP11	
iPad Pro (3rd Gen)	11"	DGSIPDP11	
iPad Pro (2nd Gen)	11"	DGSIPDP11	
iPad Pro (1st Gen)	11"	DGSIPDP11	
iPad Air (4th Gen)	10.9"	DGSIPDA109	
iPad Mini (6th Gen)	8.3"	DGIPMN06	BNDIPMN6
<b>Samsung Galaxy Tab</b>			
Samsung Galaxy Tab A8	10.5"	DSGTA8	BNDTA8
Samsung Galaxy Tab A7	10.4"	DSGTA7	BNDTA7

Scan to visit our  
websites

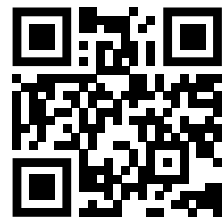

Visit Compulocks

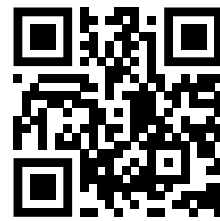

Visit Maclocks

**COMPULOCKS**  
DISPLAY. SECURE. ENGAGE

**Let's Meet!**

Contact us

[www.compulocks.com](http://www.compulocks.com)

[b2b@compulocks.com](mailto:b2b@compulocks.com)