

# COMPULOCKS

DISPLAY. SECURE. ENGAGE

## Catalog Fall 2023





# ABOUT US

Compulocks is the leading design manufacturer of IT hardware security and tablet display solutions for businesses and across industries.

With an in-house R&D team and an understanding of every work environment's needs, we provide our clients with high end customer specific products that elevate their work, operations, and communications.



## Quality Assurance

Durable materials for long term usage



## Security Experts

Creating security solutions for over 10 years



## International Service

Operation in North America and Europe serving the world

FORTUNE  
**500**

## Fortune 500

Chosen by companies from start-up to Fortune 500





# I'M LOOKING FOR...

- 06 Recently Launched >
- 09 Wall Displays >
- 10 Counter Stands >
- 11 Floor Stands >
- 12 Rolling Stands >
- 13 Other Mounts >
- 14 Apple Mounts >
- 15 Ergonomic Solutions >
- 16 Locks >
- 18 POS Terminal Solutions >
- 19 Protective Solutions >
- 19 Store & Charge >
- 21 Custom Solutions >

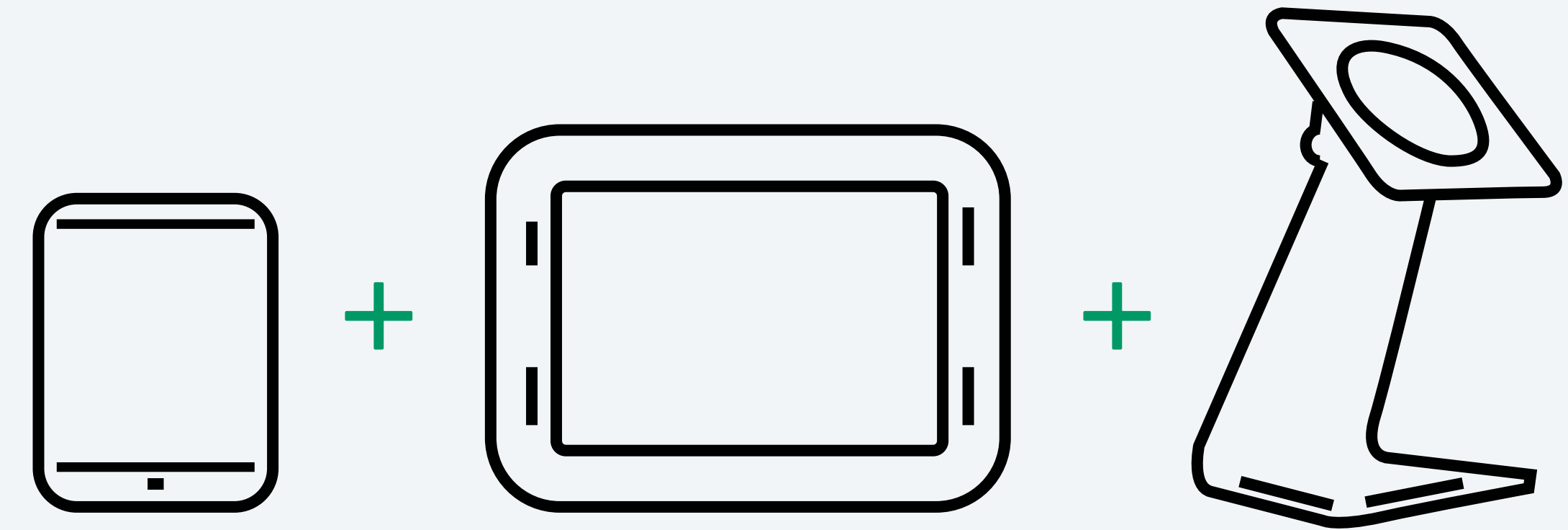

**Salespeople report that cross-selling generates upto 30% more revenue\***

*\*Source: Hubspot Blog*





In 2023 our focus is on the future. With our design and engineering experience we are committed to improving **the ways people work**. We are launching new products that **enhance connectivity** and enable the advances in technology to benefit every workplace.



# HOW DO YOU WANT TO MOUNT YOUR TABLET?

All of Compulocks' tablet holders can be paired with any of our floor, wall, or counter displays to fit every tablet and use case

Compulocks allows you to create your best combination, here are a few examples.

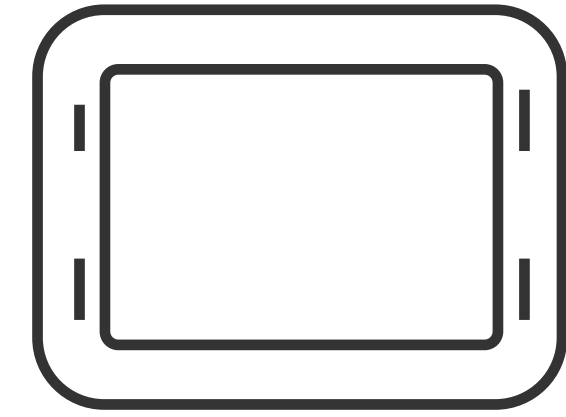

## Space

Swing Arm

Brandable  
Floor Stand

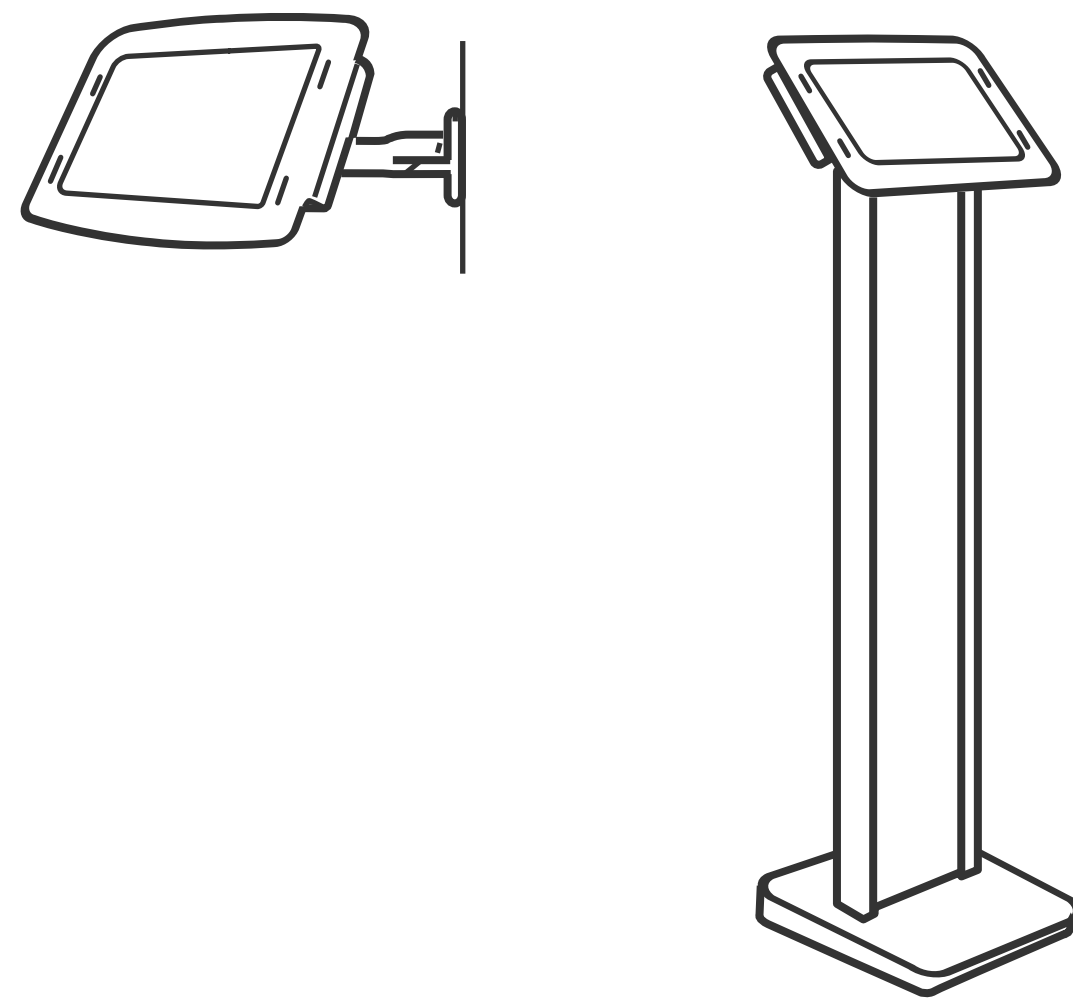

Enclosed  
Secured with key  
Stylish design

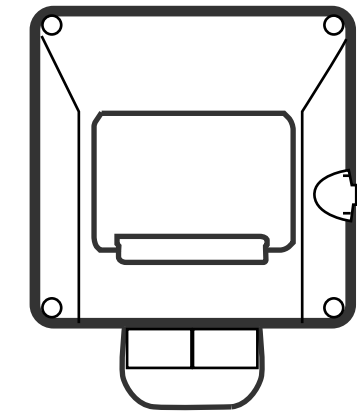

## PowerMove

Wall Mount

Rise Stand

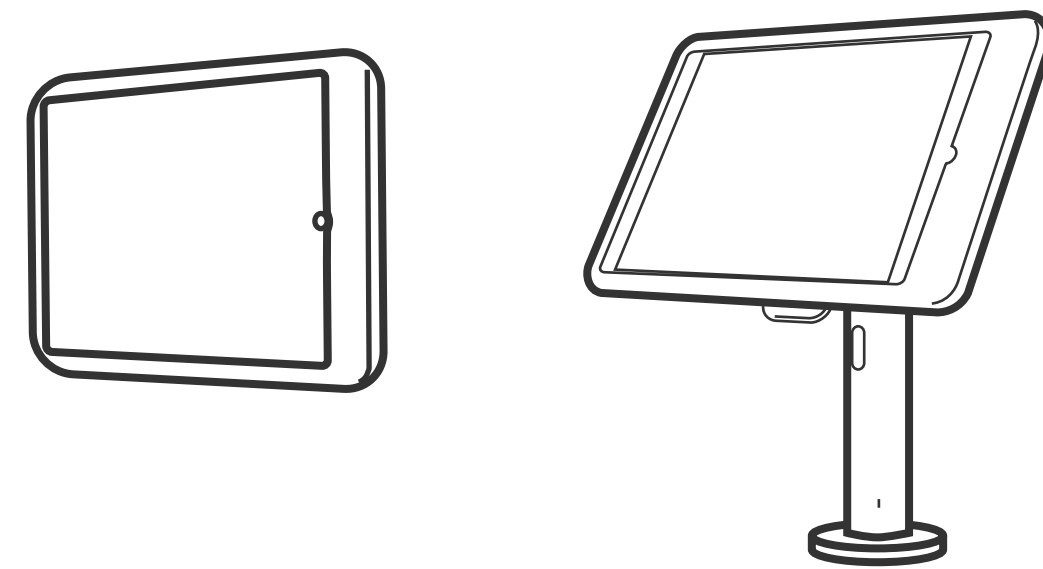

Charging display  
Click on/off  
Allows Mobility

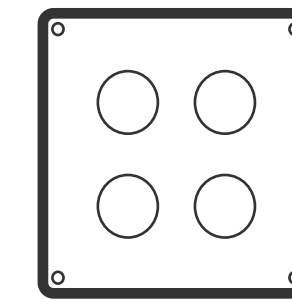

## Magnetix

AV Capsule Stand

Core Stand

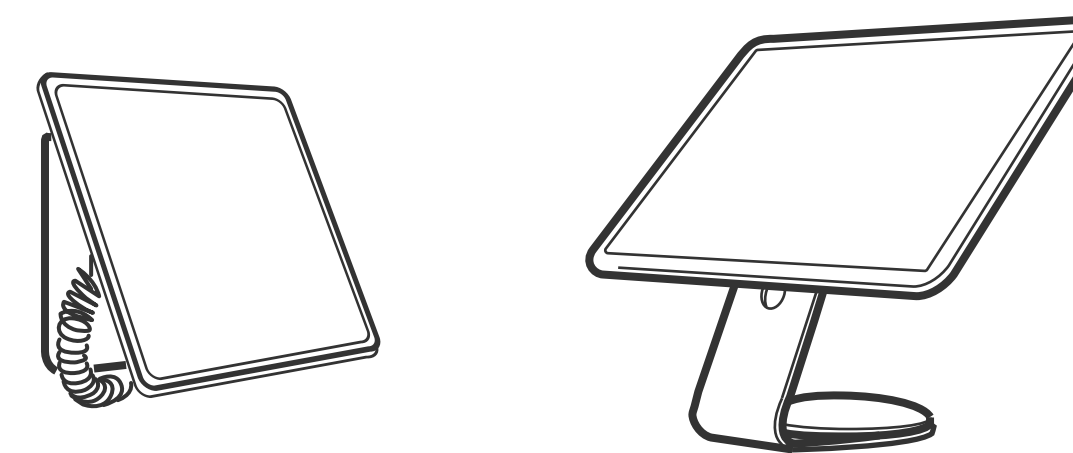

Universal  
Allows mobility  
Click on/off

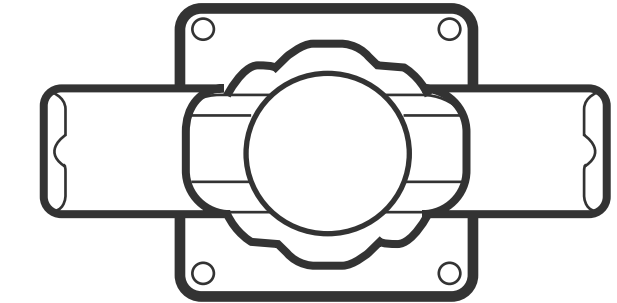

## Cling

360 Stand

Adjustable Stand

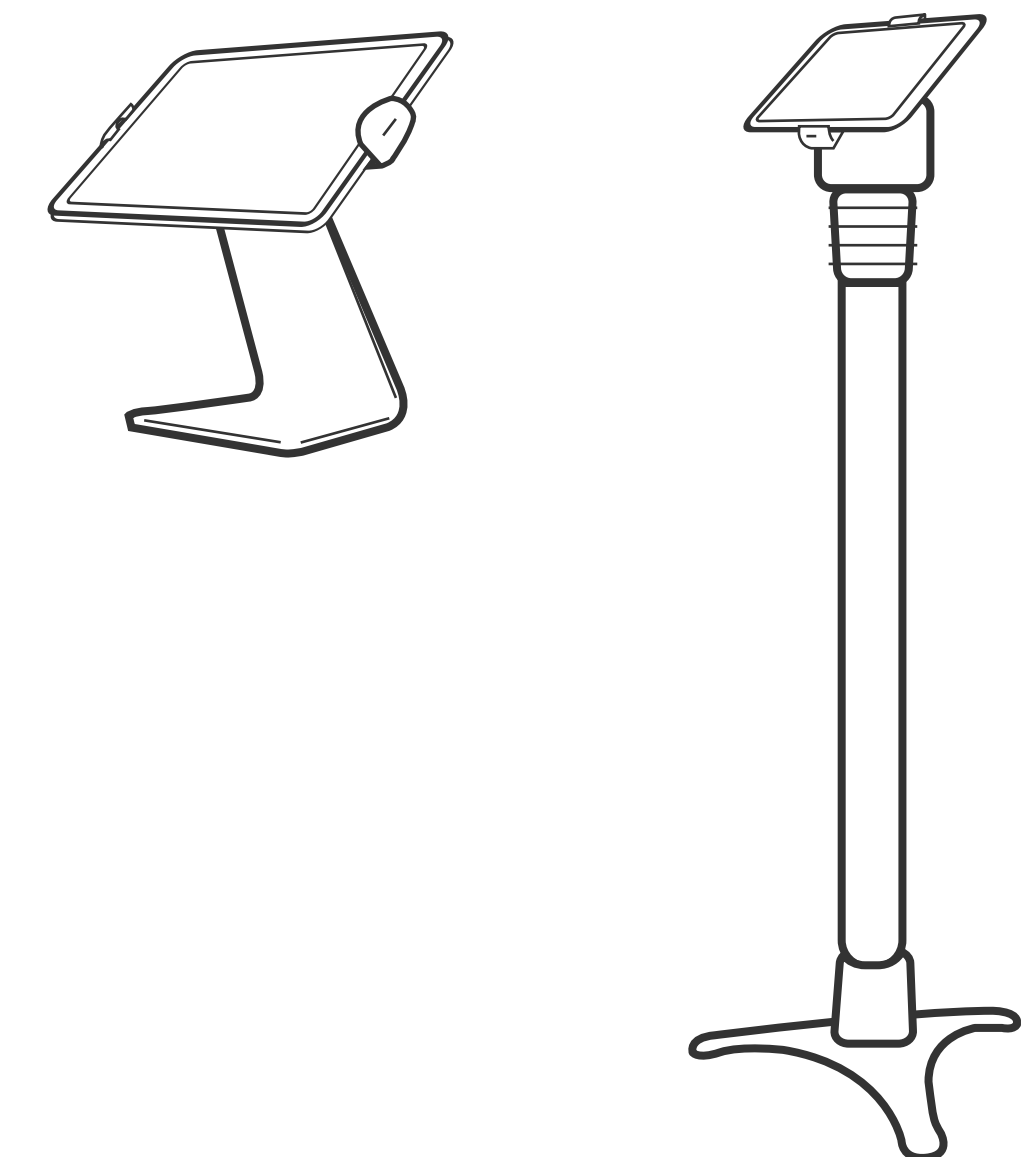

Universal  
Portrait\Landscape orientation  
Intuitive design





# POWERMOVE NEW!

PowerMove's all-in-one design provides a single solution with multiple functions. With its smart Click on/off feature, you can easily attach and remove your iPad for seamless mobile use and securely lock your tablet in place when desired.

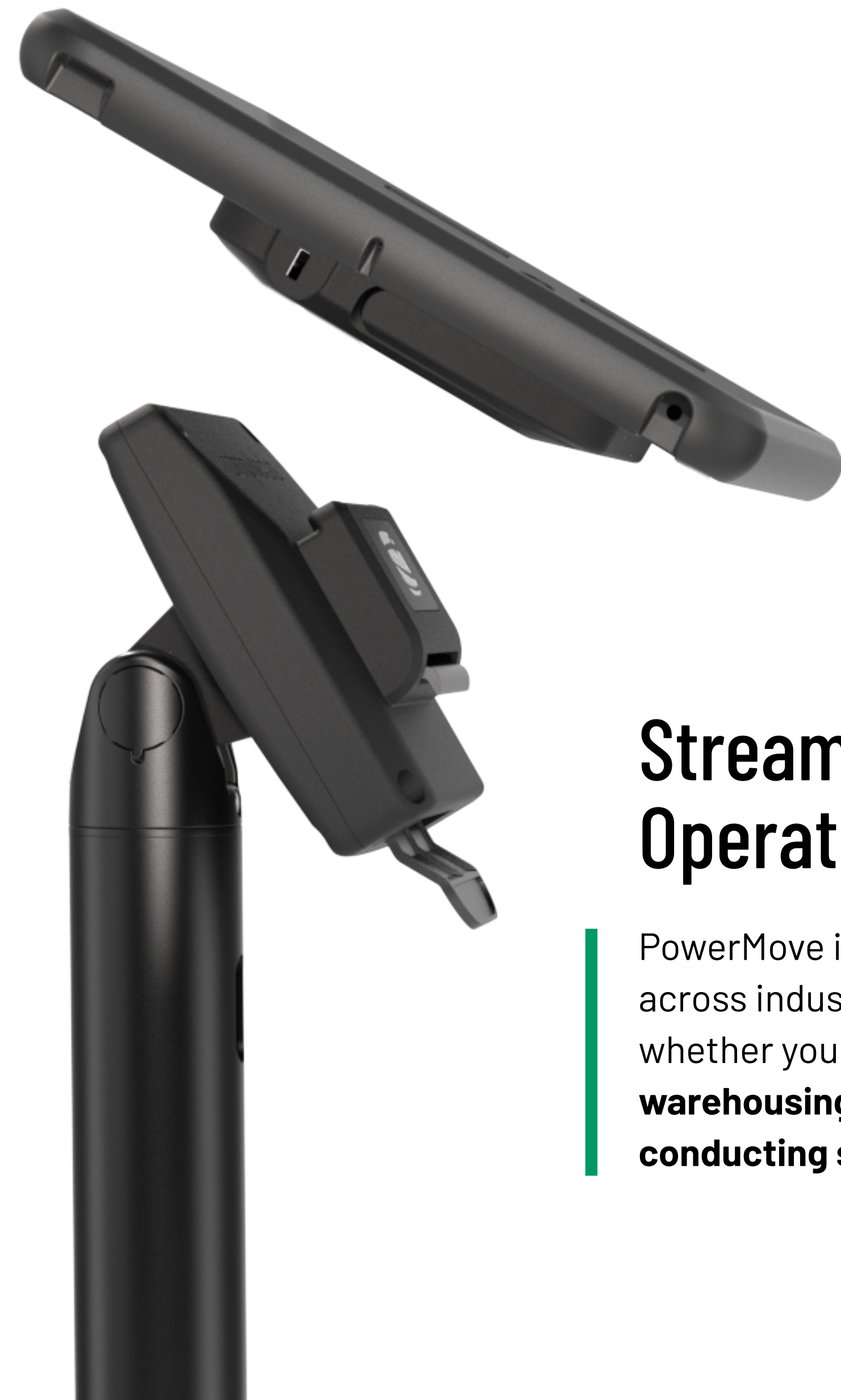

## Streamline Your Operations

PowerMove is the ideal **solution**, across industries and use needs - whether you are in **custom service, warehousing, Quality Control or conducting sales** on the go.

## Mobility. Connectivity. Security.

The keyed locking **mechanism** ensures 100% peace of mind, keeping your iPad **secure in any environment**. Plus, with convenient pogo pins for charging and data, your iPad will always be powered up and ready for action.



### THE POWERMOVE FEATURES

100x100mm  
VESA Mount

- Pogo pins for connectivity and charging
- Allows data and power transfer through USB-C interface
- Locking mechanism for tablet security
- Direct charging port when detached from dock
- Edge Case to conceal wiring and protect connections and tablet
- Easy to use "lift to release" mechanism
- Integrated kickstand on tablet side

### COMPATIBILITY

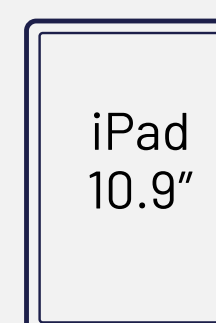

iPad  
10.9"

\* The solution is compatible with any device as the Edge Band is replaceable to fit any tablet model.



### SKU & INFO

Product	SKU
PowerMove	PMIP109





SKU: 111B209IPDSBH01

## +HUB NEW!

The Plus Hub is a multi-functional media add-on that transforms your tablet use. Combined with our range of counter, wall or floor stands, the Plus Hub is a streamlined and aesthetic solution to organize connectivity.

Group your wires and ports and create a **clean and organised setup** that enhances your workspace.

## Connectivity Re-imagined

Connect your iPad to a large screen for immersive **presentations**, link it to a printer or scanner for seamless document management, or effortlessly connect a keyboard for enhanced productivity. **The Plus Hub makes it all simpler and more efficient.**

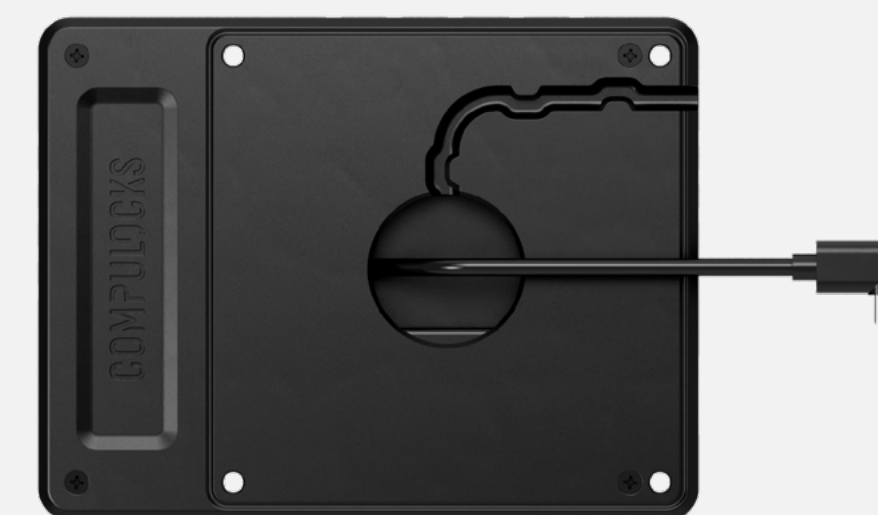

### THE +HUB FEATURES

100x100mm  
VESA Mount

- Hub ports specification : USBPD, USB-C, HDMI, 2xUSB-A, RJ45
- Allows data and power transfer through USB-C interface
- Ventilation holes incorporated to ensure proper temperature regulation
- Option for direct wall mounting

### SKU & INFO

Product	SKU
PlusHub	H01





SKU: 102KS01KL, VFRT650M

## SECURED KICKSTAND NEW!

Robust yet **lightweight**, the Secured KickStand allows you to **handle, work with and display** your tablet whilst enjoying unmatched **mobility**. The rugged rubber Edge Case provides extra protection and all bundles come with a locking solution to ensure 100% device security.

[LEARN MORE](#)

## Unlimited functionality

Fitting **trade shows**, in a **retail** environment or **healthcare** setting, Secured KickStand provides the perfect solution for every use case.



7.5° position



### SECURED KICKSTAND FEATURES

- Metal kickstand for durability
- 6ft Keyed Cable Lock included
- Dual angle - 7.5° and 30° stances
- Rubber feet for stability and traction
- Easy installation with 3M VHB pads

### COMPATIBILITY



### SKU & INFO

Product	SKU
iPad 10.9" Secured KickStand	109KS01KL
iPad 10.2" Secured KickStand	102KS01KL
iPad mini 8.3" Secured KickStand	830KS01KL
Galaxy Tab A8 10.5" Secured KickStand	105KS01KL



# WALL DISPLAYS

Compulocks' wall displays are compatible with every iPad and tablet made by leading brands.



Portrait Or  
Landscape  
Orientation

## Swell

NEW!

100x100mm  
VESA Mount

75x75mm  
VESA Mount

Compatible 

- Sleek all metal frame
- Closed with tamper-proof screws
- Direct access to charging cable
- Option for direct wall mounting
- Exposed front and back cameras and sensors

[LEARN MORE](#)



Portrait Or  
Landscape  
Orientation

## Space Enclosure

100x100mm  
VESA Mount

Compatible



- High-grade aluminum Enclosure with rounded edges
- Quick Keyed access
- Conceals charging cable
- Designed to expose cameras and sensor

[LEARN MORE](#)



## Cling Wall Mount

100x100mm  
VESA Mount

Compatible



- Universal, compatible with iPads / tablets 7" - 13", Max thickness: 9.3mm
- Rotates between portrait and landscape orientations
- Tamper proof design
- Secure cable management

[LEARN MORE](#)

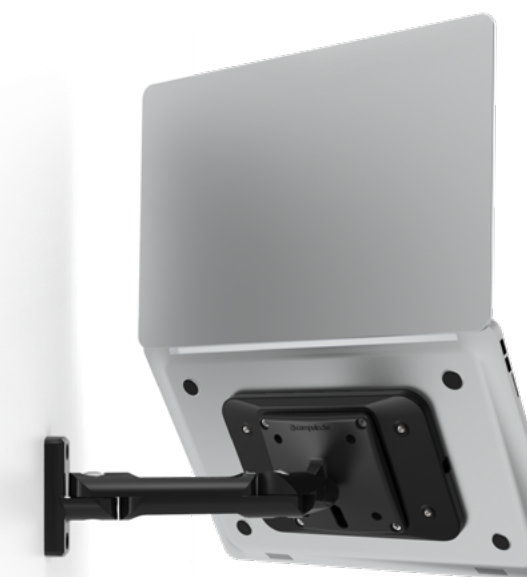

## Invisible Swing Wall Mount

100x100mm  
VESA Mount

- Universal, compatible with any iPad / tablet / laptop with min. 8" x 5" flat fixing area
- Tilt, pan, and swing for multiple display angles
- Industrial strength adhesive

[LEARN MORE](#)

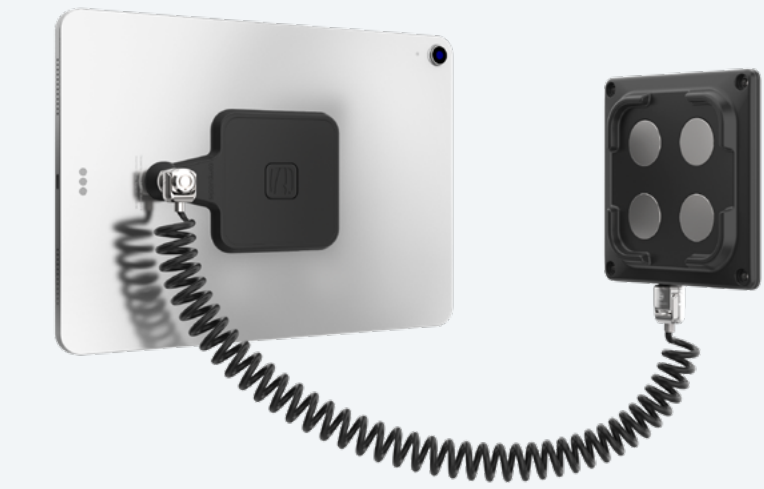

## Magnetix Wall Mount

100x100mm  
VESA Mount

- Universal mount system for all iPads / tablets
- For Displays and Handheld use, cable lock secured
- Easily switch between landscape and portrait orientations

[LEARN MORE](#)



## Space Enclosure Swing Wall Mount

Best Seller

100x100mm  
VESA Mount

- Conceals charging cable
- High-grade aluminum enclosure
- Quick lock and unlock keyed lock
- Tilt, pan, and swing for multiple display angles

[LEARN MORE](#)



# COUNTER STANDS



## Space Enclosure Core Stand

**NEW!**

100x100mm  
VESA Mount

75x75mm  
VESA Mount

- Powder coated steel stand
- Enclosure can be set in landscape or portrait orientation
- Wall or countertop mountable
- Add-on adhesive and Swivel bases

[LEARN MORE](#)



## Space Enclosure Rotating Stand

**Best Seller**

100x100mm  
VESA Mount

- 90° screen rotation
- Full reverse screen tilt
- Weight balanced base
- Customer-oriented design

[LEARN MORE](#)



## HoverTab Lock Stand

**Best Seller**

- Universal tablet and iPad stand
- Portrait or landscape orientation
- Keyed lock for easy removal
- 60° table top, 30° wall mounted viewing angle

[LEARN MORE](#)



## Invisible Mount Rise Stand

100x100mm  
VESA Mount

75x75mm  
VESA Mount

- Height options available
- Through arm cable management
- Swiveling and tilting mount head
- Optional adhesive and free-standing bases

[LEARN MORE](#)



SKU: 111B209SWLB



## Magnetix AV Capsule Stand

100x100mm  
VESA Mount

- Concealed storage space for cables and battery
- 30° table top, 60° wall mounted viewing angle
- Built-in cable lock slot

[LEARN MORE](#)



## Secured KickStand

**NEW!**

- Metal kickstand for durability
- 6ft Keyed Cable lock included
- Dual angle - 7.5° and 30° stances
- Rubber feet for stability and traction
- Easy installation with 3M VHB pads

[LEARN MORE](#)



## Cling Stand

- Fixed angle secure stand
- Tamper proof design
- 90° screen rotation
- VHB and screw mounts included
- Optional rotating base included

[LEARN MORE](#)



# FLOOR STANDS

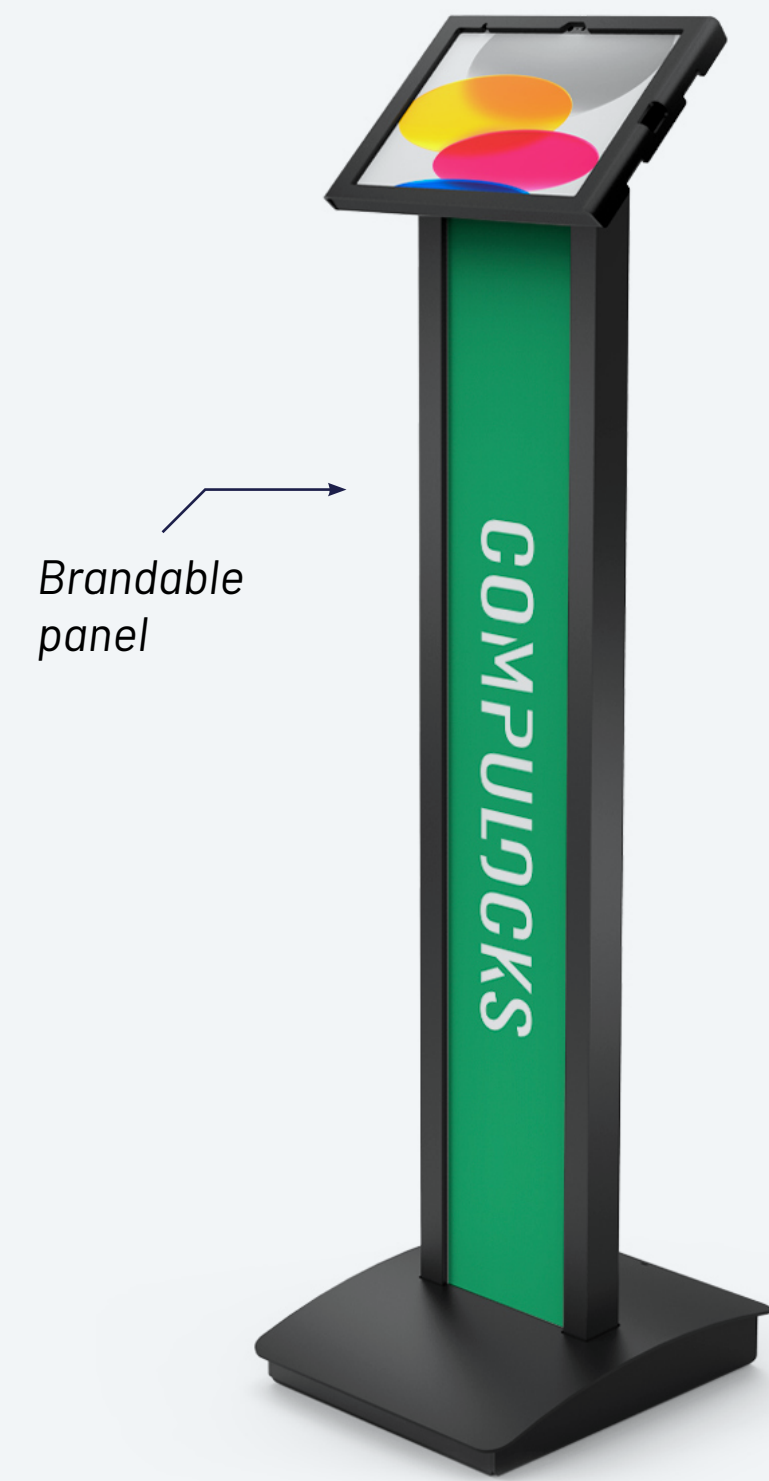

## Brandable Floor Stand

100x100mm  
VESA Mount

- Tilting 100 & 75 VESA mounting plate
- Panel for branding, call to action, or custom design
- Cable management for charging while mounted
- Concealed storage space for adaptor, batteries, etc.

[LEARN MORE](#)

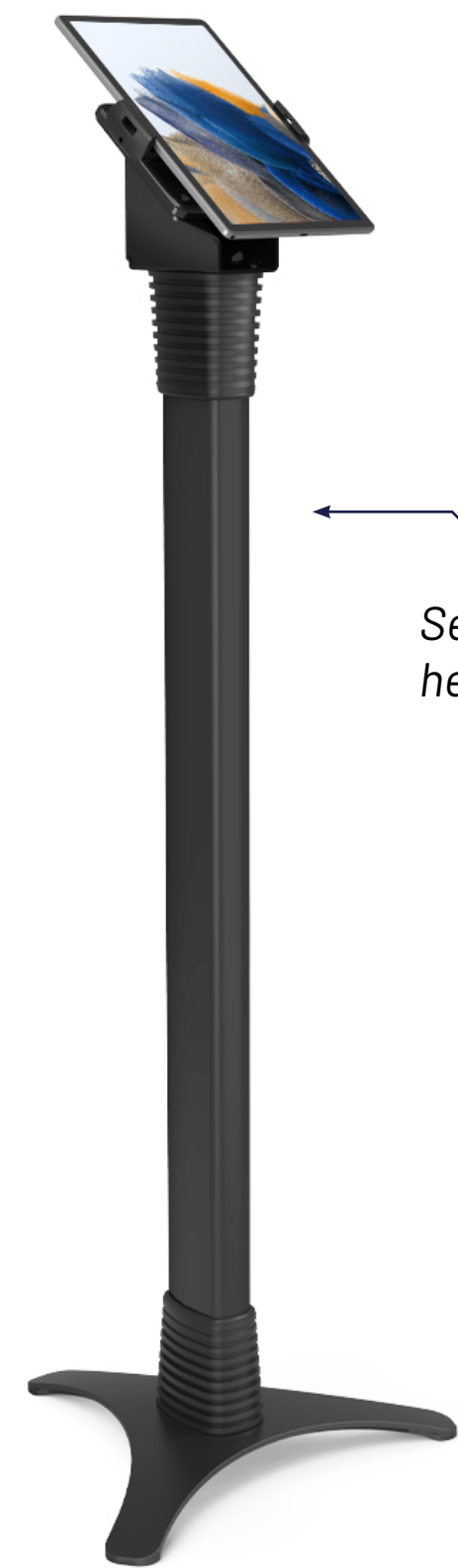

## Portable Floor Stand

100x100mm  
VESA Mount

- Floor stand with adjustable height
- Fixed 45° viewing angle
- Cable management through the pole
- Space for charging block

[LEARN MORE](#)



SKU: MCRSTDEXW102IPDSW



# ROLLING STANDS

## Tablet Rolling Cart

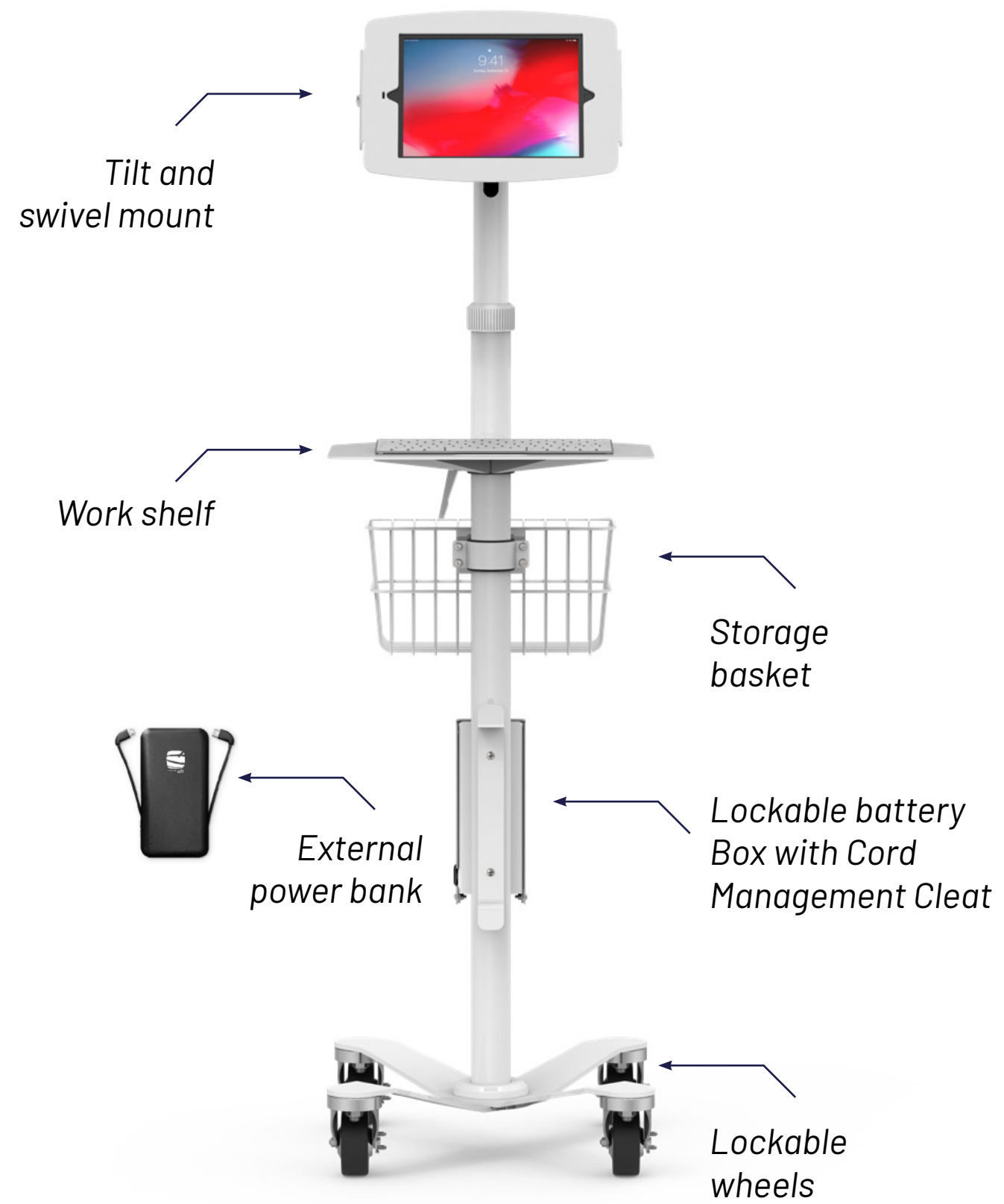

100x100mm VESA Mount    75x75mm VESA Mount

- Dynamic, rolling, hands-free workstation
- Through pole cable management
- Adjustable height and viewing angles
- Rolls easy and fits in tight places
- Perfect for healthcare and medical settings

[SEE MORE](#) [LEARN MORE](#)

## Tablet Extended Rolling Cart

2023 Best Seller



[LEARN MORE](#)



SKU: MCRSTDEXW105GA8S



# OTHER MOUNTS



## Glass Mount

100x100mm  
VESA Mount

- Securely mount any iPad or tablet on smooth surfaces including marble and glass; no drilling required
- Easy to install and can be removed using a dedicated tool (supplied separately)
- Powerful VHB adhesive pads to fix to glass and other smooth surfaces

[LEARN MORE](#)



## Rail Mount

75x75mm  
VESA Mount

100x100mm  
VESA Mount

- Fix to rails 12.7mm (0.5") Ø to 38.0mm (1.50") Ø
- 360° screen swivel
- 125° screen flip

[LEARN MORE](#)



SKU: 201MGLUCLGVWMB



# MAC STUDIO LOCKS



## Ledge Lock

- Unique ledge lock adapter mechanism
- Creates accessible T-Bar lock slot compatible with standard cable locks
- Non invasive
- Discrete low profile solution

[LEARN MORE](#)

## Stand



- Mac Studio secured with cable lock to stand or fixed point
- Increases ventilation and decreases dust accumulation
- Allows use of standard T-Bar cable locks
- Maintains small footprint
- Additional T-Bar lock slot for peripheral

[LEARN MORE](#)

## Mount



- Secures directly to a flat surface or freestanding secured with cable lock
- Additional T-Bar lock slot for peripheral
- Ventilated design
- Unrestricted access to ports

[LEARN MORE](#)



SKU: MSBKT01

# APPLE MOUNTS



## Apple TV Security Mount

Best Seller

[Compatible with all Apple TV models](#)

- Easy fix to any flat surface
- Lightweight and low profile
- Ventilated aluminium construction
- Security Slot for lockhead or cable lock

[LEARN MORE](#)



## Mac mini Security Mount

Best Seller

- Lightweight and low profile
- High-grade aluminum construction
- 100x100mm and 75x75mm VESA Mounting Pattern
- Security Slot for lockhead or cable lock

[LEARN MORE](#)



# ERGONOMIC ARMS

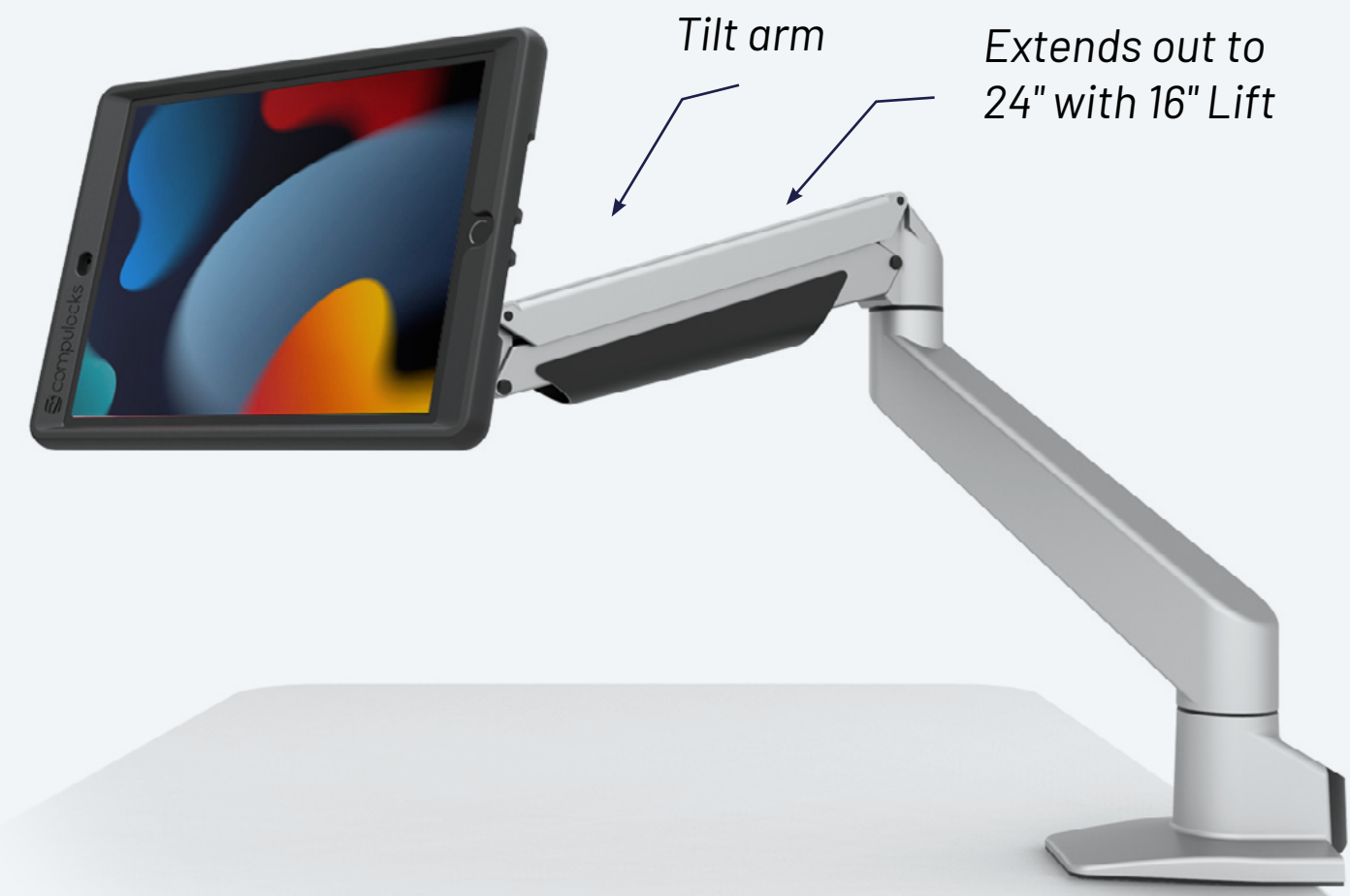

## Articulating Arm

75/100mm  
VESA Mount

- Wide range of motion: tilt, swing, and pan
- Clamp-on, mount through desk or wall mount
- Cable management keeps all wires and cords organized

[LEARN MORE](#)



## Extra Long Articulating Arm

100x100mm  
VESA Mount

- Extra-long 4 ft. arm
- Ergonomic monitor arm
- Suitable for hospitals, clinics, and patient monitoring applications or interactive bedside entertainment systems

[LEARN MORE](#)

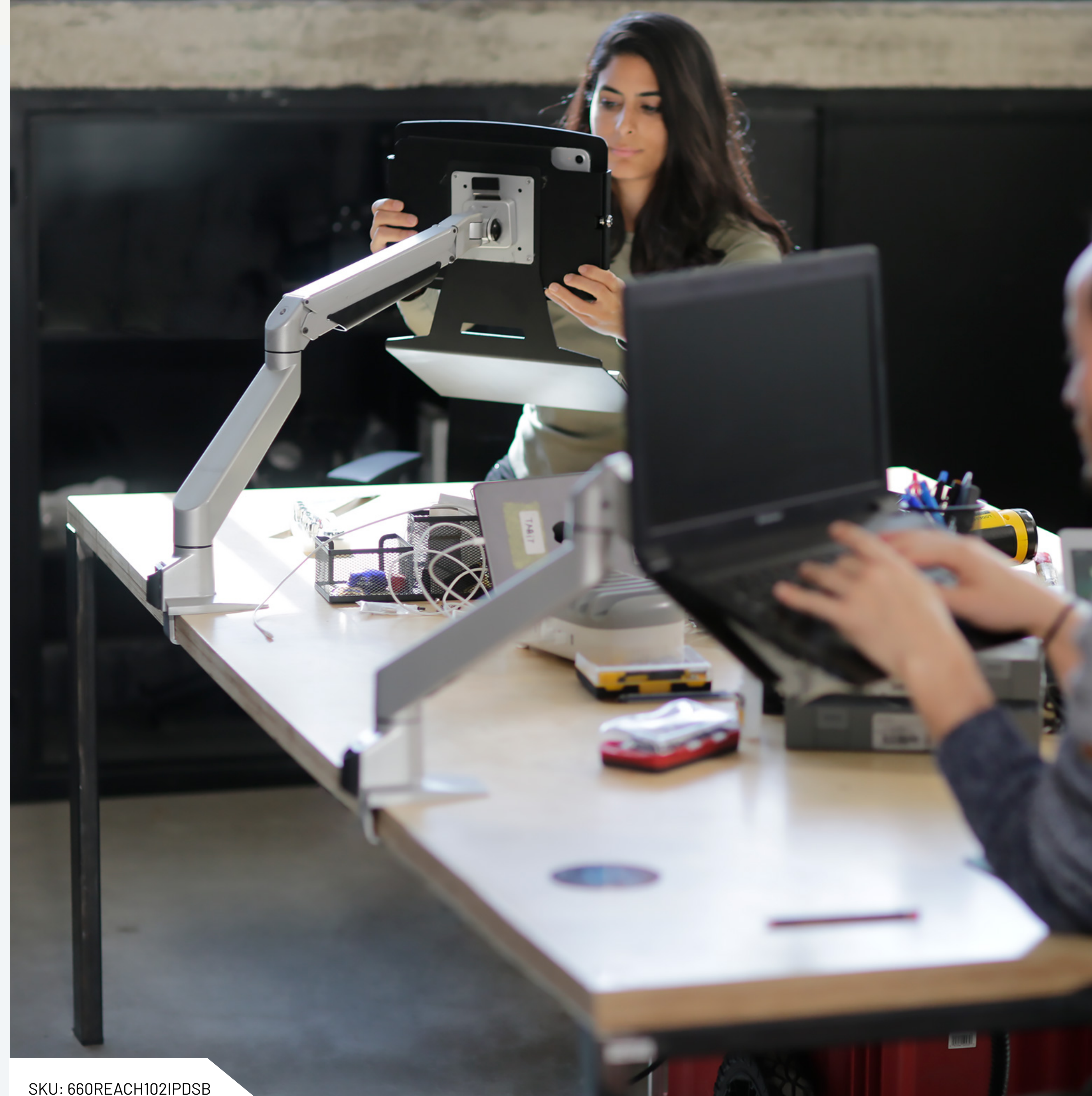

SKU: 660REACH102IPDSB



## DID YOU KNOW?

The FBI's National Crime Information Center estimates that each year up to 800,000 memory devices (laptops, tablets etc) are lost or stolen. Due to their value, securing Macbooks, Laptops and iPads is more urgent than ever.

Compulocks offers a range of security solutions for any device.

\*Source: forbes.com

# LOCKS

## LOCK ADAPTERS & CABLE LOCKS



### Universal Tablet Lock

Best Seller

Compatible     

- Low-profile Universal Security Plate
- 3M VHB industrial adhesive
- 6ft galvanized steel cable lock
- Loop ended cable for easy tethering

[LEARN MORE](#)



### Blade Universal Lock

Compatible     

- Universal for any device
- Extremely durable
- Compatible with standard T-bar cable lock
- Retractable "Blade" security slot

[LEARN MORE](#)



### Surface Ledge Lock Adapter

Compatible 

- Patented design for Surface Pro & Go devices
- Easy lock and release mechanism
- Fits perfectly on the kickstand
- Compatible with standard T-bar cable lock

[LEARN MORE](#)



SKU: CL15



### Keyed Cable Lock

6ft T-Bar universal keyed cable lock

[LEARN MORE](#)



### Combination Cable Lock

6ft T-Bar universal combination cable lock

[LEARN MORE](#)



# MACBOOK LEDGE LOCK

## Compatible with all MacBooks

All Apple MacBook Pro & Air come with no means to secure them from theft. Compulocks produces an exclusive line of T-Slot adaptors called "Ledge" for each model of MacBook Pro and MacBook Air.



- Models compatible with all MacBook Pro and Air
- Compatible with standard T-Bar cable locks
- Cutting edge design for maximum security
- Small size and weight

[LEARN MORE](#)



SKU: MBPR16LDG02KL



# POS TERMINAL SOLUTIONS



## EMV SlideDock Security Stand

100x100mm VESA Mount    75x75mm VESA Mount    Compatible 

- Universal Device Security Stand
- Quick Connect Docking Plate
- Optional Included Rotation Plate
- Counter-top or Wall Mountable
- Simple, Stylish, and Secure
- Comes with VHB Pad and Swivel base

[LEARN MORE](#)



## Verifone T650m and CM5 Rugged Cases

- Nesting silicon and hard plastic cases for maximum Shock and Drop protection
- Easy Grip surface
- Compatible with Magnetic Charging Cable
- Full access to controls and ports

[LEARN MORE](#)

## UNIVERSAL HAND GRIP

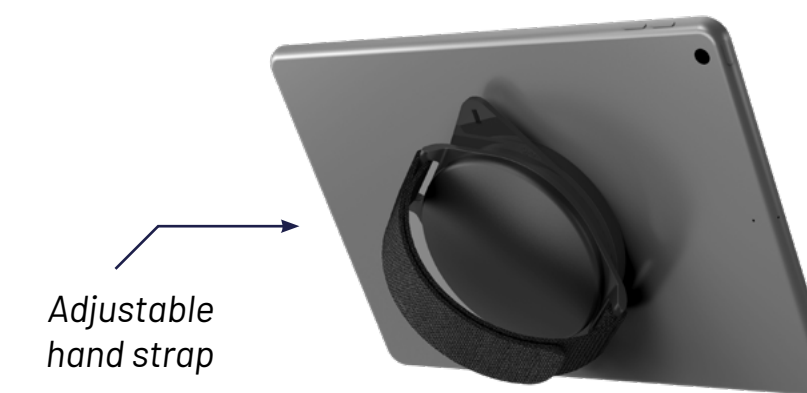

## Hand Grip

- Universal to fit all tablets and iPads
- Adjustable strap for a comfortable fit, even with gloves
- Industrial-strength adhesive
- 360 degrees screen rotation

[LEARN MORE](#)



## Verifone T650m and CM5 Multichargers

- Simultaneously charge upto 5 devices
- Magnetic Charging Connection
- High-grade aluminum station
- Countertop or Wall mountable
- For use with Rugged Cases

[LEARN MORE](#)



## Grip & Dock Station

- Secured 'Grab and Go' iPad/tablet stand
- Quick Keyed lock and release system
- Wall or countertop mount

[LEARN MORE](#)



# PROTECTIVE SOLUTIONS



## Edge Case

### Rugged silicon protection

- Rubberized for a firm grip and protection
- Cutouts for buttons, ports, and cameras
- Open back area for universal adhesive locking mechanisms

[LEARN MORE](#)



## Screen Shield

### Tempered glass screen protector

- Shatter-proof and scratch-resistant
- Maintains touchscreen sensitivity
- Crystal clear image resolution
- Nano-coating to repel finger marks and dust

[LEARN MORE](#)



SKU: DGSIPD109



# SECURED POWERSTRIP NEW!

Introducing Compulocks' new and innovative solution to secure and protect Apple Power Adapters and cables.



## Protection & Ease

Designed to end the **inconvenient and expensive** replacement of cables and Power Adapters through theft and loss, the Secured PowerStrip has 6 sockets for **multiple Apple devices**, in a protective case with access to on/off switch. It creates an anti-theft **multi-port USB-C charging system**, with the charge cubes provided with your devices

## Functional Installation

PowerStrip is **easily mounted** in countertop and wall locations, providing the **ultimate** protection and deterrence.



### THE SECURED POWERSTRIP FEATURES

- 6 socket powerstrip
- Cable protection and strain relief
- High-grade Aluminum casing
- Can secure 2 AC power cables (upto 0.39" / 10 mm Ø)
- Power Strip on/off
- reset switch accessible while secured
- Security Lock slot



### COMPATIBILITY

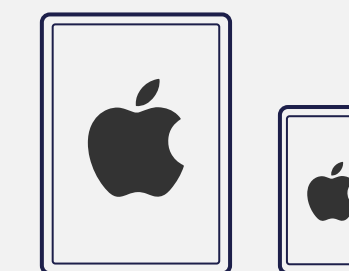

### SKU & INFO

Product	SKU
PowerStrip EU	SPWSB-EU
PowerStrip US	SPWSB



# CUSTOM MADE SOLUTIONS

Work culture is changing all the time and every work environment has different and specific needs. With a track record of delivering transformative, functional experiences across the world, we are dedicated to advancing brands' messages and vision by creating the right solution for any organization.

[LEARN MORE](#)



2023 Custom Case Study

## NFC ENCLOSURE

Enclosure with embedded Near Field Communication (NFC) add-on. Ideal for registration, logging in, payments, verifying identities and much more.

The NFC Enclosure was made for a school, to allow children to register using a chip. Attendance is clearly communicated throughout the organization, and the tablet allows the team to be informed with data concerning the children's care.



**LET'S MEET!**

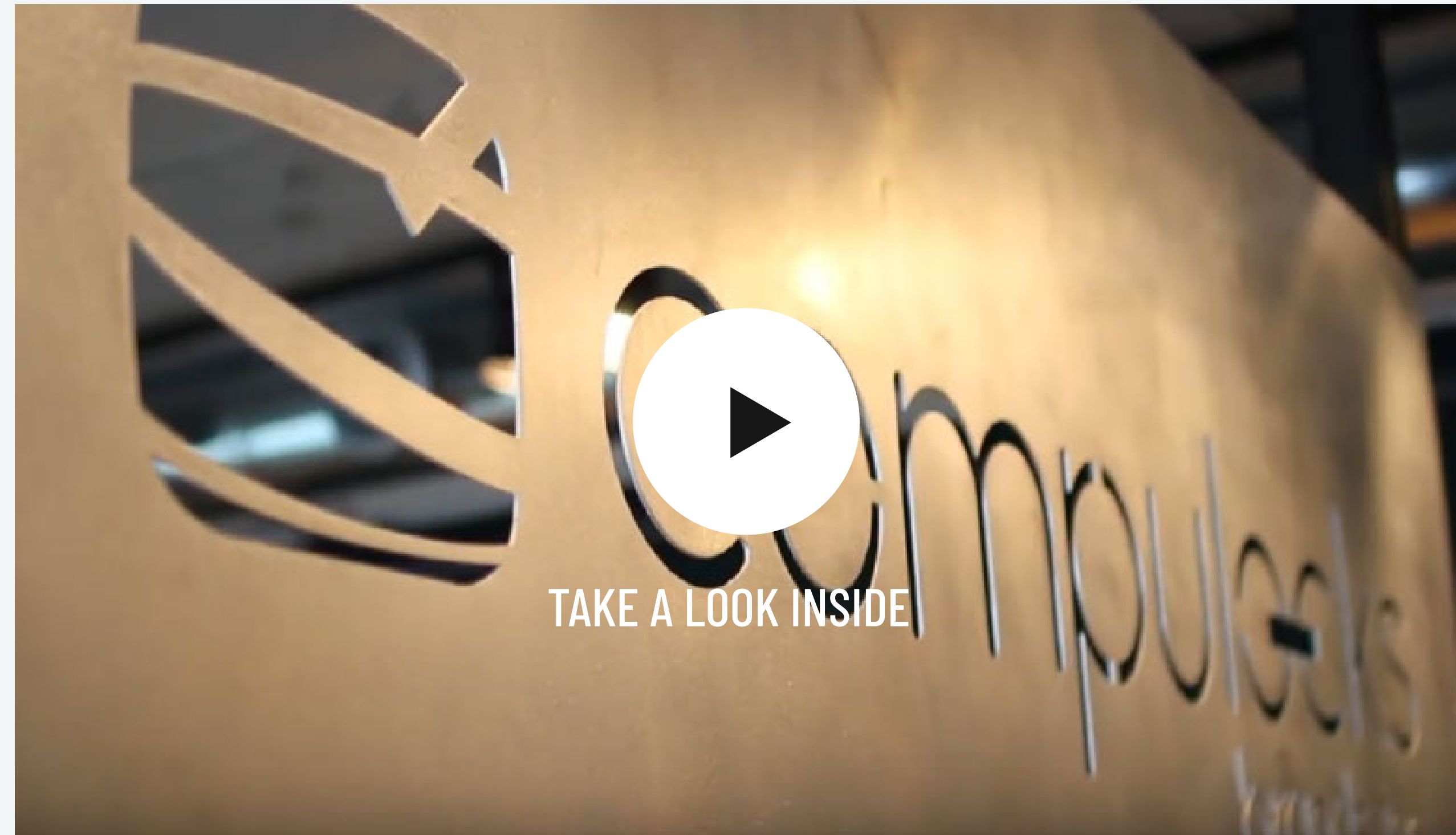

**Contact us**

[www.compulocks.com](http://www.compulocks.com)

[b2b@compulocks.com](mailto:b2b@compulocks.com)